

Cordless Endo Motor with Apex Locator

Tri Auto ZX2

INSTRUCTIONS FOR USE

CE
0197



Thank you for purchasing the Tri Auto ZX2.

For optimum safety and performance, read this manual thoroughly before using the instrument and pay close attention to warnings and notes.

Keep this manual in a handy place for quick and easy reference.

Trademarks (™) and Registered Trademarks (®) :

The names of companies, products, services, etc. used in this manual are either trademarks or registered trademarks owned by each company.

© 2019 J. MORITA MFG. CORP.

Overview and Features

Description of Icons



Normal Canals

Canals with normal shapes. This is for most canals.



Complex Canals

Extremely curved canals, ledged canals, blocked canals, etc.



Apex Location Linkage

If the contrary electrode is applied to the patient, the instrument can be linked to the apex location function while it is being used.

Canal Shapes

Almost all canals can be treated with the default settings of the memories from m1 to m4. (p.16)

If using this instrument for the first time, refer to "Canal Shaping (for normal canals)". (p.20)

Modes

The Tri Auto ZX2 has 5 different operating modes which can be used for depending on your intended use. (p.10)

Memories

There are 8 memories with different combinations of motor operation, speed etc. that can be used at different stages of the treatment. Memory settings can be customized. (p.34)

Before Use

p. 12

Canal Treatment

p. 16

Turn Power On

Press the Main switch.

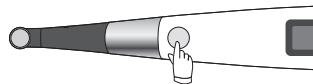

1 Upper Part Shaping

Enlarge the upper part of the canal to make treatment easier



Memory: m2
Mode: CW
p.20 2



Memory: m2
Mode: CW
p.22 2

2 Apex Location

Make an apex location to determine the working length.



Memory: m1
Mode: EMR
p.18



Memory: m1
Mode: EMR
p.18

3 Glide Path

Use a thin file to make the glide path needed for shaping



Memory: m3
Mode: OGP
p.21 4



Memory: m5 or m6
Mode: OGP
p.23 4 5

4 Canal Shaping

Change file sizes as you shape the canal.



Memory: m4
Mode: OTR
p.21 5



Memory: m7
Mode: OTR
p.23 6

Turn Power Off

Hold the Select switch and then press the Main switch.

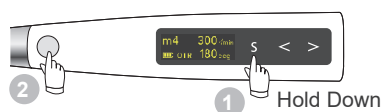

Canal shaping can be safely made by linking to the apex location function.

Rotation is controlled automatically at a point specified inside the canal. This ensures safety by preventing over instrumentation of the apical foramen.

- **OAS (Optimum Apical Stop)**
File reverses slightly and then stops.
 - **Auto Apical Reverse**
File automatically reverses rotation.
 - **Auto Apical Stop**
File stops automatically.
- (Apical Action p.37)

For Apex Location and Apex Location Linkage

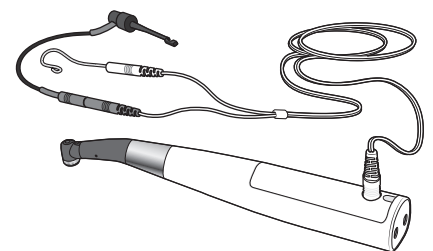

Glide path can be made with the motor.

The motor reproduces the subtle and delicate finger movements of an experienced dentist. Penetration can be performed efficiently with a thin Ni-Ti file or stainless steel file.

(OGP Function p.40)

Canal shaping can be made safely and efficiently without distorting the original shape.

The file alternates between forward and reverse rotation delicately in response to the load applied to it. This makes for safe and efficient treatment by reducing jamming, breakage, ledge formation, and over instrumentation.

(OTR Function p.40)

Reprocessing

p. 28

Table of Contents

Overview and Features	3
Prevent Accidents	6
Parts Identification and Display Screens	8
Parts Identification	8
Display Screens for 5 Operation Modes and Standby	10
Display during Operation	11
Usage	12
1. Operating, Transport and Storage Environments	12
2. Before Use	12
Assembling Components	12
Connect Contra Angle	12
Put on HP Protective Sleeve	12
Connect Probe Cord	13
Install File	13
Operation Check	14
Check Apex Location Function	14
Check Motor	14
Calibration	15
Check with Tester	15
3. Operation	16
Default Settings	16
Apex Location	18
Canal Shaping (for normal canals)	20
Canal Shaping (for complex canals)	22
Root Canals Not Suitable for Electric Apex Location	24
4. After Use	25
Turn Power Off	25
Take Out the File	25
Remove HP Protective Sleeve	25
Battery Charging	26
5. Reprocessing	28
Parts to be Sterilized	29
Parts to be Disinfected	33
How to Make Various Settings	34
Rotation Controls	34
Default Memory Settings	34
Set Operation Mode	35
Operation Mode	35

Set Speed and Torque.....	36
Speed (r/min).....	36
Torque (N•cm).....	36
Settings for Apex Location Linkage.....	37
Settings.....	37
Apical Action.....	37
Auto Start.....	38
Auto Stop.....	38
Flash Bar Position.....	38
Set Other Functions.....	39
Apical Slow Down.....	39
Torque Slow Down.....	39
Apical Torque Down.....	40
Rotation Angle.....	40
OGP Mode.....	40
OTR Mode.....	40
Beeper Volume.....	40
Other Handpiece Functions.....	41
Default Handpiece Settings.....	41
Set Handpiece Functions.....	41
Auto Power Off Time.....	41
Auto Return to Standby Display.....	41
Dominant Hand.....	41
Startup Memory Number.....	41
Reset Memories to Original Default Settings.....	42
Replacement Parts.....	43
External File Electrode.....	45
Maintenance and Inspection.....	47
Troubleshooting.....	48
1. Troubleshooting.....	48
2. Abnormal Stop.....	50
3. Error Numbers.....	50
Technical Specifications.....	51
Symbols.....	52
Service Contacts.....	53
Consumable and Replacement Parts.....	53
Electromagnetic Disturbances (EMD).....	54

Prevent Accidents

Attention Customers

Do not fail to receive clear instructions concerning the various ways to use this instrument as described in this accompanying Operation Instructions.

Fill out and sign the warranty and give the dealer from whom you purchased the instrument a copy.

Attention Dealers

Do not fail to give clear instructions concerning the various ways to use this instrument as described in this accompanying Operation Instructions.

After instructing the customer in the operation of the instrument, have him fill out and sign the warranty. Then fill in your own section of the warranty and give the customer his copy. Do not fail to send the manufacturer's copy to J. MORITA MFG. CORP.

Prevent Accidents



Most operation and reprocessing problems result from insufficient attention being paid to basic safety precautions and not being able to foresee the possibilities of accidents.

Problems and accidents are best avoided by foreseeing the possibility of danger and operating the instrument in accordance with the manufacturer's recommendations.

First, thoroughly read all precautions and instructions pertaining to safety and accident prevention; then, operate the instrument with the utmost caution to prevent either damaging the instrument itself or causing bodily injury.

Do not use this instrument for anything other than its specified dental treatment purpose.

The following symbols and expressions indicate the degree of danger and harm that could result from ignoring the instructions they accompany:

-  **WARNING** This alerts the user of possibility of extremely serious injury or complete destruction of the instrument as well as other property damage including the possibility of fire.
-  **CAUTION** This alerts the user of possibility of minor or moderate injury or damage to the instrument.
-  This informs the user of important points concerning operation or the risk of instrument damage.

The user (e.g., healthcare facility, clinic, hospital etc.) is responsible for the management, maintenance and use of medical device.

This instrument must only be used by dentists and other legally licensed professionals.

WARNING

- No modification of this instrument is allowed.
- Do not use the wireless transmission devices listed below in the examination area:
 1. Mobile terminals and smart devices.
 2. Wireless transmitting devices such as ham radios, walkie-talkies, and transceivers.
 3. Personal Handy-phone System (PHS)
 4. Routers for intra-building paging systems, wireless LAN, cordless analogue telephones, and other electric wireless devices.
- This instrument could be adversely affect by the electromagnetic radiation produced by electric scalpels, illumination devices etc. that are being used nearby.
- Do not perform maintenance while using the instrument for treatment.
- Always wear personal protective equipment (PPE) such as safety glasses, gloves, a mask, etc. when using and reprocessing the Tri Auto ZX2.

PROHIBITION

- Do not use this instrument on patients who have implanted pacemakers or defibrillators.

Disclaimer

J. MORITA MFG. CORP. will not be responsible for accidents, instrument damage, or bodily injury resulting from:

1. Repairs made by personnel not authorized by J. MORITA MFG. CORP.
2. Any changes, modifications, or alterations of its products.
3. The use of products or equipment made by other manufacturers, except for those procured by J. MORITA MFG. CORP.
4. Maintenance or repairs using parts or components other than those specified by J. MORITA MFG. CORP. and other than in their original condition.
5. Operating the equipment in ways other than the operating procedures described in this manual or resulting from the safety precautions and warnings in this manual not being observed.
6. Workplace conditions and environment or installation conditions which do not conform to those stated in this manual such as improper electrical power supply.
7. Fires, earthquakes, floods, lightning, natural disasters, or acts of God.

J. MORITA MFG. CORP. will supply replacement parts and be able to repair the product for a period of 10 years after the manufacture of the product has been discontinued. For the duration of this period, we will supply replacement parts and be able to repair the product.

In Case of Accident

If an accident occurs, the Tri Auto ZX2 must not be used until repairs have been completed by a qualified and trained technician authorized by the manufacturer.

For customers who use the Tri Auto ZX2 in the EU:

If any serious incident occurs in relation to the device, report it to a competent authority of your country, as well as the manufacturer through your regional distributor. Observe relevant national regulations for detailed procedures.

User Qualifications

Intended Operator Profile

- a) Qualification : Legally qualified person such as dentists for endodontic device operation (it may differ among countries).
- b) Education and Knowledge : It is assumed that the user understands the risks of apex location and canal treatment. It is also assumed the user is thoroughly familiar with apex location and treatment including the prevention of cross contamination.
- c) Language Understanding : English (Intended for professional use as described above)
- d) Experience : Experienced person with operating endodontic device.
No special training is required except in cases where this is required by legal regulations of the relevant country or region.

Patient Population

Age : Child to Elderly

CAUTION

- This device is not recommended for use in children under 12 years of age.

Weight : Not applicable

Nationality : Not applicable

Sex : Not applicable

Health : It is not intended for use on patients wearing pacemakers or ICDs.

Condition : Conscious and mentally alert person. (Person who can stay still during treatment.)

Parts Identification and Display Screens

Parts Identification



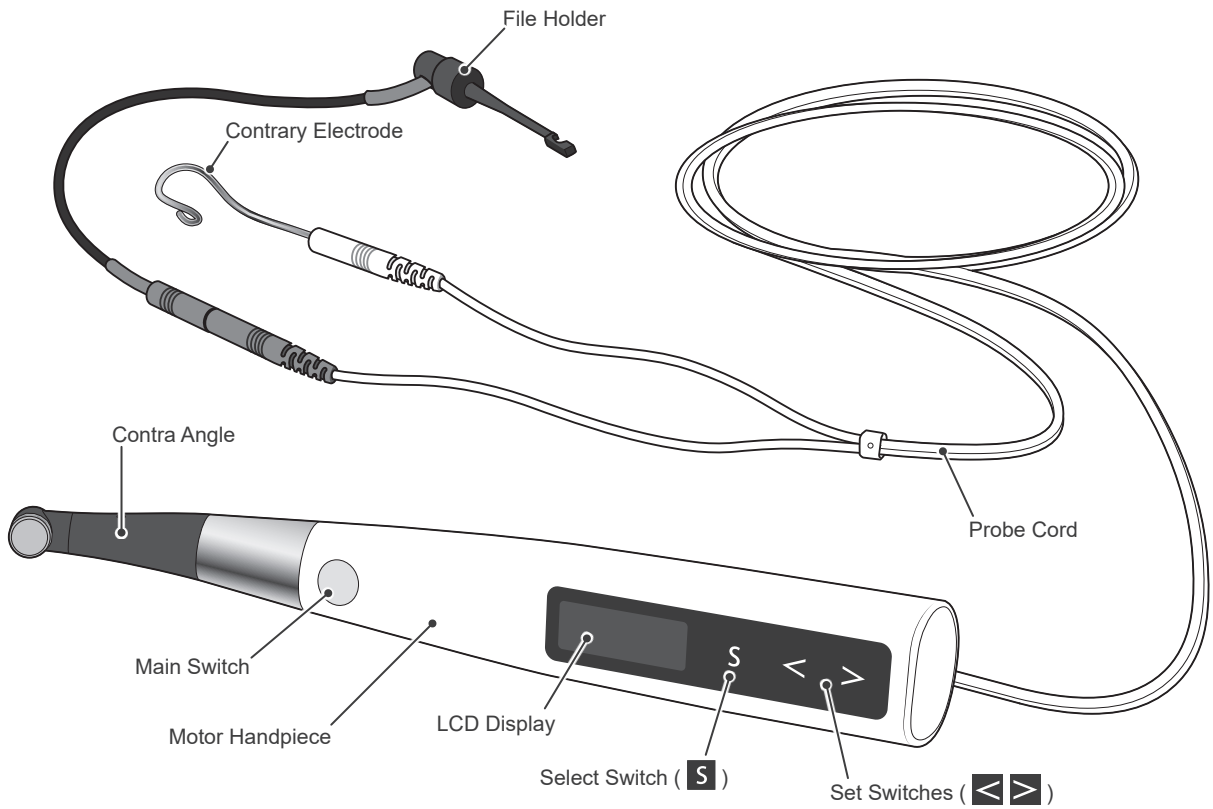



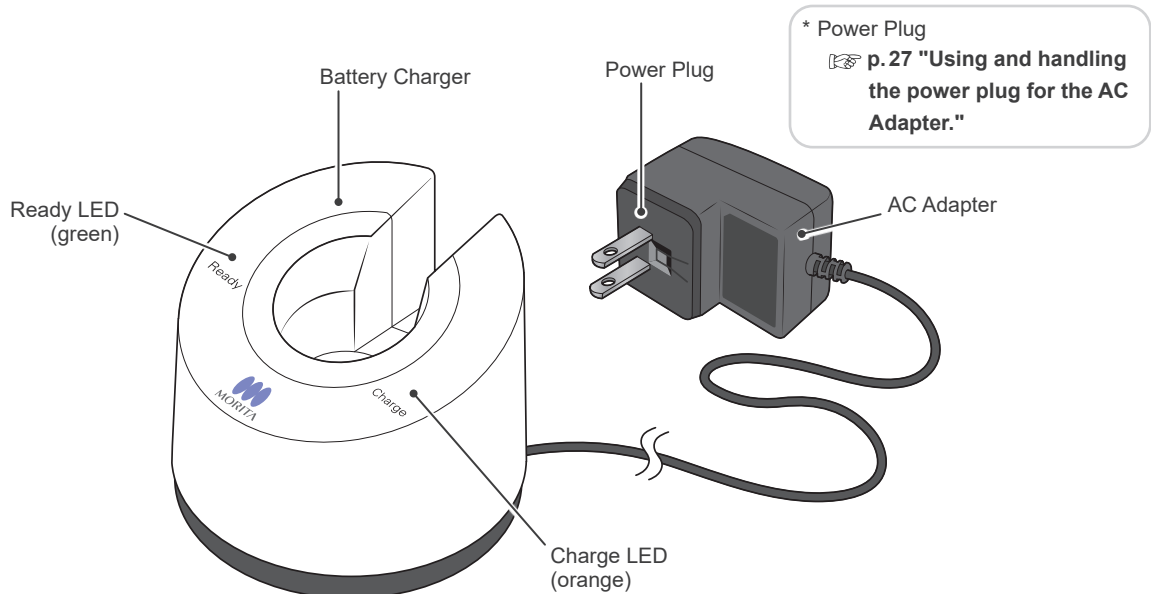



■ Handpiece

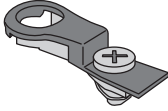
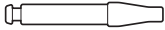
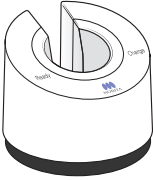

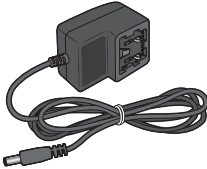
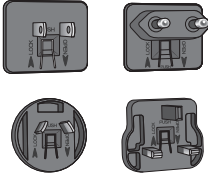
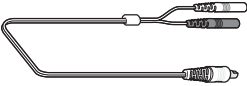
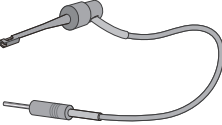

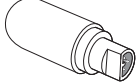

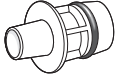
■ Battery Charger



■ Components

<p>Motor Handpiece (1)</p> 	<p>Contra Angle (1)</p> 	<p>Built-in Electrode * Pre-installed in Contra Angle</p> 	<p>Guide Bar (1) * Use the guide bar when replacing the built-in electrode or external file electrode. ☞ p.44 "Replacing Built-in Electrode" ☞ p.45 "External File Electrode"</p> 
<p>Battery Charger (1)</p> 	<p>Battery * Pre-installed in Motor Handpiece</p> 	<p>AC Adapter (1)</p> 	<p>Power Plugs (one each of 4 types)</p> 
<p>Probe Cord (0.75m) (1)</p> 	<p>File Holder (1)</p> 	<p>Contrary Electrodes (3)</p> 	<p>Tester (1)</p> 
<p>HP Protective Sleeve Type A (30) * Replace for each patient. Never reuse.</p> 	<p>Spray Nozzle (1) * Keep this nozzle and use it again when replacing the spray can. For maintenance of contra angle, the MORITA MULTI SPRAY with the spray nozzle or LS OIL may be used.</p> 	<p>MORITA MULTI SPRAY (1) (sold separately)</p> 	

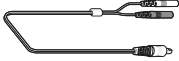
■ Options (sold separately)

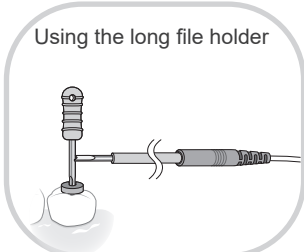
<p>Handpiece Holder</p> 	<p>External File Electrode (with cap)</p> 	<p>Probe Cord (1.8m)</p> 	<p>Long File Holder</p> 	<p>Using the long file holder</p> 
---	---	--	--	---

Display Screens for 5 Operation Modes and Standby

EMR Mode

This mode is for the apex location.

* The motor does not run in this mode.

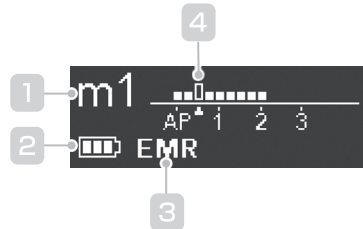

- 1 Memory No.
- 2 Residual Battery Power
- 3 Operation Mode
- 4 Flash Bar Position

CW Mode

The motor rotates forward 360°.

Torque reverse and other functions can be used.

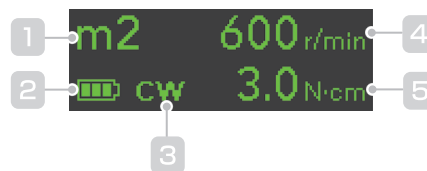

- 1 Memory No.
- 2 Residual Battery Power
- 3 Operation Mode
- 4 Speed Setting
- 5 Torque Limit Setting

OGP Mode

The OGP (Optimum Glide Path) function (p. 40) is used for canal negotiation and making the glide path.

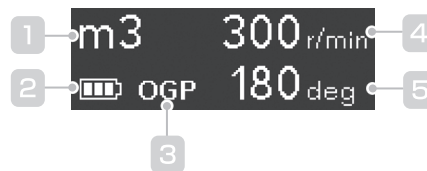

- 1 Memory No.
- 2 Residual Battery Power
- 3 Operation Mode
- 4 Speed Setting
- 5 Rotation Angle

OTR Mode

The OTR (Optimum Torque Reverse) function (p. 40) is used for canal shaping.

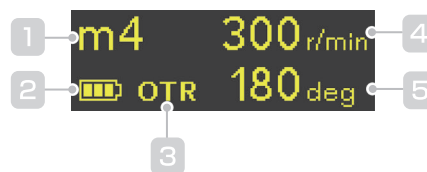

- 1 Memory No.
- 2 Residual Battery Power
- 3 Operation Mode
- 4 Speed Setting
- 5 Rotation Angle

CCW Mode

The motor rotates counterclockwise only. This mode is used to inject calcium hydroxide and other medicant.

* When this mode is being used, a double-beep sounds continuously.

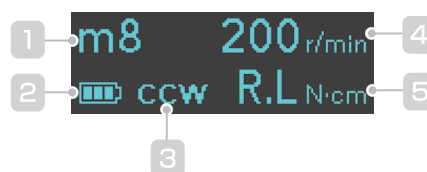

- 1 Memory No.
- 2 Residual Battery Power
- 3 Operation Mode
- 4 Speed Setting
- 5 Torque Limit Setting

Display during Operation

■ Torque Display (This appears when the motor is running.)

Meter shows the torque load on the file. The color of the display changes depending on the torque load as shown below.

⚠ There could be some discrepancy in the torque value; the displayed torque should be used only as a reference value. Failure to properly perform the contra angle's reprocessing procedures may result in a decline in cutting efficiency or in performance degradation of the motor.

When discrepancy between the displayed and actual torque was suspected, perform the reprocessing of the contra angle, and ask for repair if failure including noise or vibration was existed. Calibration shown in p. 15 is also recommended.

Torque Value
0 – 2.0 N·cm

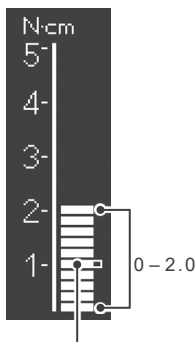

Torque Limit or Trigger Torque
(p. 36)

Torque Value
2.2 – 4.0 N·cm

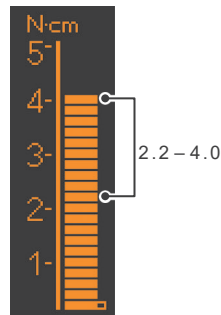

Torque Value
4.2 – 5.0 N·cm

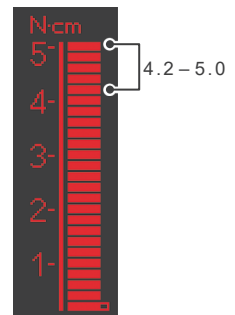

■ Apex location Display

(This appears when a file is inside the canal and the contrary electrode is contacting the patient.)

Bars in meter show the location of the file tip. The color of the display changes depending on location of the file inside the canal as shown below.

* The meter numbers 1, 2, and 3 do not represent the actual length from the apical. These numbers are used to estimate the canal's working length.

Location Inside Canal
0 – 13 bars

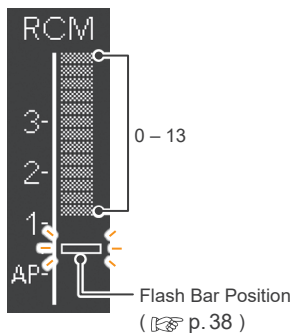

Alarm Sound:
slow beep

There is slow beeping sound between bars 10 – 13.

Alarm Sound:
continuous beep

A sustained beep sounds when the file tip reaches the flash bar point.

Location Inside Canal
14 – 18 bars

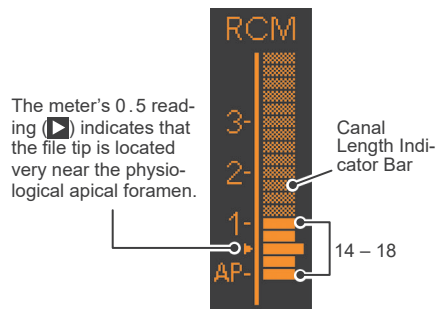

Alarm Sound:
fast beep

There is fast beeping sound between bars 14 – 18.

Alarm Sound:
continuous beep

A sustained beep sounds when the file tip reaches the flash bar point.

Location Inside Canal
19 – 20 bars

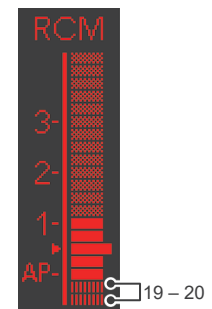

Alarm Sound:
continuous beep

A sustained beep sounds if the file tip goes this far.

Usage

1. Operating, Transport and Storage Environments

Operating Temperature: +10 °C to +35 °C (+50 °F to +95 °F)
Humidity: 30 % to 80 % (without condensation)
Atmospheric Pressure: 80 kPa to 106 kPa

Transport and Storage Temperature: -10 °C to +45 °C (+14 °F to +113 °F)
Humidity: 10 % to 85 % (without condensation)
Atmospheric pressure: 70 kPa to 106 kPa

- * Do not expose the Tri Auto ZX2 to direct sunlight for an extended period of time.
- * If the instrument has not been used for some time, make sure it works properly before using it again.
- * Always remove the battery prior to storing or shipping the instrument. p. 43

2. Before Use

Be sure to perform reprocessing on the respective parts before using them for the first time. p. 28 "5. Reprocessing"

Check the following before using the instrument.

- Have the autoclavable parts been sterilized? p. 29 "Parts to be Sterilized"
- Have the disinfectable parts been disinfected? p. 33 "Parts to be Disinfected"
- Is the battery sufficiently charged? p. 26 "Battery Charging"
- Is the file appropriate for the Tri Auto ZX2? p. 13 "Install File"

Assembling Components

1 Connect Contra Angle

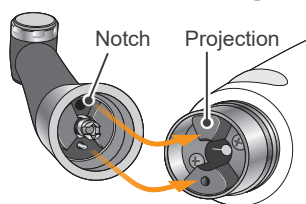

Line up the notch inside the contra angle with the projection inside the motor and slide it in until it clicks securely into place.

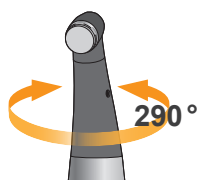

The contra angle rotates 290° so that the LCD display can always be viewed easily.

WARNING

- Make sure the connection ends of the motor handpiece and the contra angle are not damaged. If these are damaged, the load on the contra angle could cause the motor to reverse rotation, and this might result in an injury to the oral cavity.

CAUTION

- Push the contra angle all the way onto the motor handpiece and then give it a light tug to make sure it is securely attached.
- The contra angle does not rotate freely. Do not try to rotate it past its stopper.

2 Put on HP Protective Sleeve

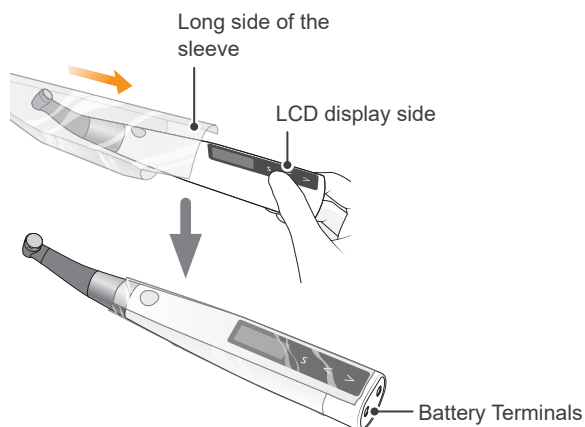

Put the protective sleeve on so that its long side is on the LCD display side.

WARNING

- To prevent cross contamination between patients, use a new sleeve for each patient. (Never reuse.)

If you hold the contra angle when you put the sleeve on, the contra angle might come off. Always put in on by pushing on the battery terminal end of the motor.

Make sure the sleeve is not torn.

3 Connect Probe Cord

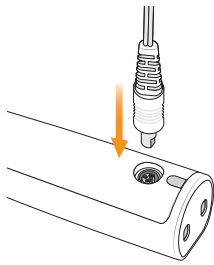

Connect the probe cord to the motor handpiece. Line up the probe jack with the notch for its mate on the back of the motor and push it all the way in.

* This step is not required if the apex location function will not be used.

⚠ CAUTION

- Do not bang or bump the plugs when they are inserted.
- Make sure the plug is all the way in. Otherwise an accurate apex location cannot be made.
- Do not wind the probe cord around the instrument.

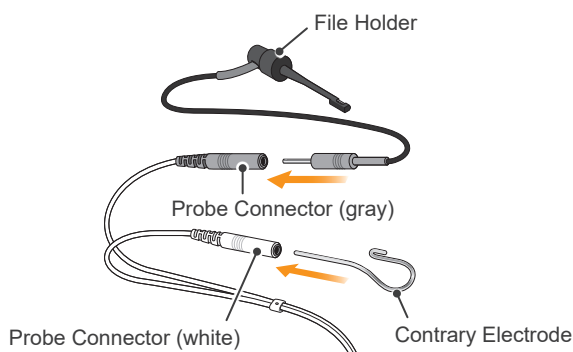

Connect the file holder plug into the probe connector (gray) on the probe cord. Connect the contrary electrode to the probe connector (white).

⚠ CAUTION

- Match colors to connect the file holder and contrary electrode. Accurate apex location cannot be made if they are reversed.

4 Install File

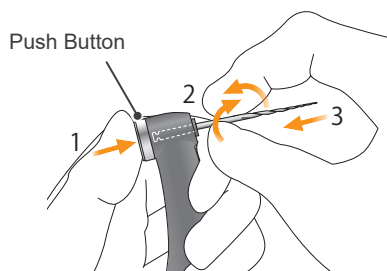

Hold down the push button on the contra angle and insert the file. Turn the file back and forth until it is lined up with interior latch groove and slips into place. Release the button to lock the file into the contra angle.

* Use only Ni-Ti or properly designed stainless steel files.

⚠ WARNING

- Files are expendable, and they eventually wear out. Replace them before they break.
- Never use stretched, deformed or damaged files.
- Make sure the file is all the way in. Give the file a light tug to confirm it is securely held in place. If the file is not securely placed, it could come out and injure the patient.
- Make sure the screw is tight enough. Otherwise, it might come out and be swallowed. Also, the apex location might not be accurate.

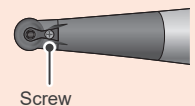

Available Files

Ni-Ti files or properly designed stainless steel files that have Type 1 shank shape of ISO 1797[†]; except for cutting in the counterclockwise direction.

[†]Plastic shank files cannot be used for the apex location linkage.



Type 1 Shank Shape

⚠ CAUTION

- Be careful when inserting and removing files to avoid injury to fingers.
- Inserting and removing files without holding the push button may damage the chuck.
- Take care not to touch the Main switch when putting files in. This will cause the file to rotate.
- If there is no electrical conductivity between the file and its shank, replace the cap with the one that has an external file electrode.
🔗 p.45 "External File Electrode"
- Do not use files with shanks larger than the ISO standard. These cannot be properly installed. (ISO standard: $\varnothing 2.334$ to 2.350 mm)

■ Check Apex Location Function



Press the Main switch to turn on the instrument.
The stand by display (m1) will appear.

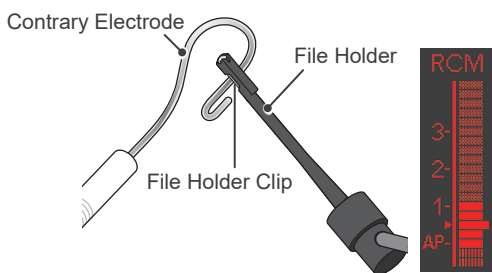

Touch the contrary electrode with the clip on the end of the file holder and check that all the indicator bars on the meter in the LCD display light up.

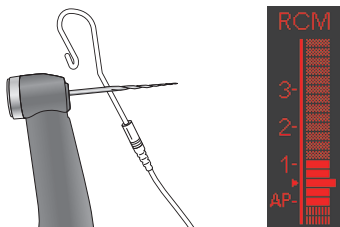

Touch the contrary electrode with the file in the contra angle and check that all the bars on the meter in the display light up.

Check the following before turning on the instrument.

- Make sure the contra angle and the motor handpiece are securely connected.
- Make sure the file is securely installed in the contra angle.
- Make sure the file holder and the contrary electrode are properly connected to the probe connector.
- Make sure the probe cord is properly plugged into its jack on the motor handpiece.

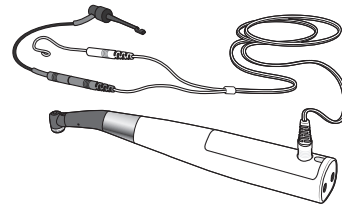

⚠ WARNING

- Check the instrument's function before use with each patient. If all the indicator bars do not light up, an accurate apex location cannot be made. In this case, stop using the instrument immediately and have it repaired.

■ Check Motor

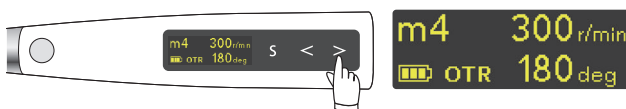

Press the Right-Set switch (➤) to select "m4" (OTR mode).



Press the Main switch and make sure the motor runs smoothly.

* This is the default setting.
If m4 is not set for OTR mode, select another memory that is set for OTR mode.

* Cannot check motor rotation in EMR mode.

The torque meter appears when the motor is running.

- ⚠ If the motor keeps alternating between forward and reverse rotation and it does not rotate forward continuously, calibrate the instrument.
- ⚠ If there are abnormal vibrations or noises, stop using the instrument immediately and contact your local dealer or J. MORITA OFFICE.

■ Calibration

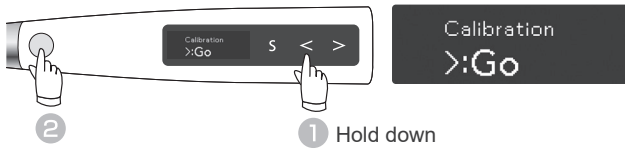

With the instrument turned off, hold down the Left-Set switch (◀) and then press the Main switch. The calibration display will appear.

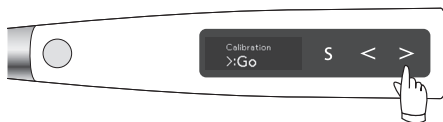

Press the Right-Set switch (▶). Calibration will be performed. After calibration, the instrument will automatically return to the Standby display.

Calibrate the instrument at the following times:

- Right after purchase.
- Whenever the contra angle has been replaced.
- When using a contra angle other than the one that has been calibrated.
- Whenever, in OTR mode, the instrument always alternates between forward and reverse rotation and never rotates forward continuously.

* Calibration is automatically performed from 100 to 1,000 r/min.

! Perform calibration with the contra head attached. If calibration is performed with a file inserted, be careful not to injure your fingers.

■ Check with Tester



Press the Main switch to turn on the instrument. The stand by display (m1) will appear.

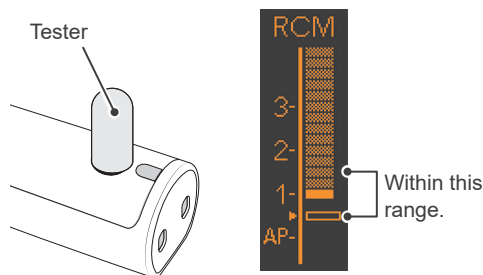

Connect the tester to the probe cord jack on the back of the motor handpiece.
Check that the canal length indicator bars light up to within two bars of bar number 1.^{*1}

Check the instrument's apex location accuracy with the tester at least once a week.

* The canal length indicator bars may flicker up or down momentarily when the tester is plugged in. Wait for about 1 second for the indicator bar to stabilize and then check it.

*1 If the meter lights up to three bars more or less than bar number 1, the instrument cannot make an accurate apex location. In this case, stop using the instrument immediately and contact your local dealer or J. MORITA OFFICE.

3. Operation

Select the memory appropriate to the treatment to be performed.

The main uses, operation modes, and apical actions for the default settings of each mode are listed below.

The following explanation is base on the default settings.



CAUTION

- Since the following is based on the default settings, use changed settings for your own treatment procedures.
- Always check the settings after changing the memory number.

Default Settings

Almost all canals can be treated with the default settings of the memories from m 1 to m 4 . However, settings can be changed to suit various stages of treatment.

We recommend using the default settings until the user has gotten used to how the instrument works.

Memory	Main Uses with Default Settings	Operation Mode  p. 35	Apical Action  p. 37
m 1	Apex location	EMR	—
m 2	Shape the upper part of canal.	CW (forward)	OAS
m 3	Negotiation and making a glide path for a normal canal	OGP	OAS
m 4	Canal shaping for a normal canal	OTR	OAS
m 5	Negotiation and making a glide path for a complex canal	OGP	OAS
m 6	Making a glide path for a complex canal	OGP	OAS
m 7	Canal shaping for a complex canal	OTR	OAS
m 8	Injection solutions such as calcium hydroxide, etc.	CCW (reverse)	Off

* Refer to page ( p. 34 "How to Make Various Settings"), for how to make and change settings.

* After changing settings, refer to page  p. 42 "Reset Memories to Original Default Settings", for how to restore the original settings.

WARNING

- Before use, run the Tri Auto ZX2 outside the oral cavity to make sure it is operating normally.
- Depending on the condition of the tooth, the type of case, and the condition of the instrument, it may not be possible to shape and make apex location properly. Make sure to take an X-ray to check the results.
- In general Ni-Ti files can sometimes wear out rather quickly depending on the shape and the degree of curvature of the root canal. Stop using the instrument immediately if tactile feedback indicates the instrument is not working properly.
- Since files can easily break due to metal fatigue and excessive load, replace them frequently. Since stainless steel files are especially easily broken, it is best to not reuse them and replace them with new ones instead.
- Electric noise or a malfunction could make it impossible to control the motor properly. Do not depend entirely on the instrument controlling itself; always watch the display, listen to the sound and be aware of tactile feedback.
- Applying excessive force at canal shaping could cause the file to jam inside the canal or break the file.
- Do not apply excessive force. Even when using the torque reverse function, files may break depending on the torque setting.
- When changing files, always examine for stretching and other deformities or damage before using them. Deformed files tend to break.
- If the contra angle's file release button is pressed against the teeth opposite the one being treated, the file could come out and injure the patient.
- Never press the push button while the motor is running. This could cause it to heat up and burn the patient. Also the file might come out and injure the patient.
- Always use a rubber dam to prevent accidental swallowing of files etc.

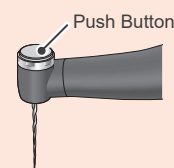

CAUTION

- Stop using the instrument immediately if tactile feedback indicates the instrument is not working properly.
- Files break more easily at high speeds; always follow the file manufacturer's recommendations. Also always check the rotation speed before using the instrument.
- Use only Ni-Ti or properly designed stainless steel files.
- Ni-Ti files break rather easily. Pay close attention to the following points:
 - Never use excessive force to insert the file.
 - All foreign matter, such as bits of cotton, should be removed from the root canal before using the file.
 - Never use excessive force to advance the file down the root canal. Ni-Ti files break easily if too much load or force is applied.
 - Take great care when working on extremely curved canals. These can break the file easily.
 - Try not to trigger the auto torque reverse function as much as possible when advancing the file down the root canal.
 - Use files in the order of their sizes without skipping any sizes. A sudden change to a larger file can lead to file breakage.
 - If you encounter resistance or the auto torque reverse is triggered, take back the file up 3 or 4 mm and carefully advance it down the root canal again. Or replace the file with a smaller size. Never use excessive force to insert the file.
 - Do not force the file down the root canal or press it against the root canal wall as it could break the file.
 - Do not use the same file continuously in one position for too long as it may lead to creating "steps" etc.
- Always remove the file after use.
- Use only files that are designed for clockwise filing. Use files very carefully and follow all the recommendations of the manufacturer.

Make an apex location and determine its working length.

1 Turn Power On



Press the Main switch to turn on the instrument. The stand by display (m 1) will appear.

EMR mode is now selected.

2 Apply Contrary Electrode

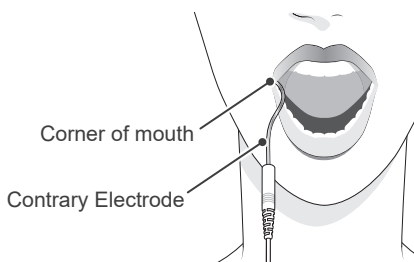

Hook the contrary electrode in the corner of the patient's mouth.

⚠ WARNING

- Never use an electric scalpel when the contrary electrode is hooked in the patient's mouth. These devices emit electrical noise that could interfere with accurate apex location or cause the instrument to malfunction.
- Make sure that the contrary electrode, file holder, and their connectors, do not come into contact with an electric power source such as a power outlet. This will result in an electric shock.
- Accurate apex location is not always possible, especially in cases of abnormal or unusual root canal morphology. Make sure to take an X-ray to check the results.
- If connections are not securely plugged in the instrument may not make an accurate apex location. If the meter does not change as the file goes down the canal, stop using the instrument immediately and make sure all the connectors are securely inserted.

⚠ CAUTION

- The contrary electrode could cause an adverse reaction if the patient has an allergy to metals. Ask the patient about this before using the contrary electrode.
- Take care that medicinal solutions such as formalin cresol or sodium hypochlorite do not get on the contrary electrode or the file holder. These could cause an adverse reaction such as inflammation.

3 Clip the File

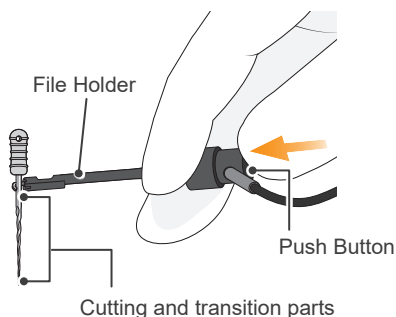

Push the button on the file holder with your thumb in the direction shown by the arrow in the illustration. Clip the holder onto the metal upper part of the file and then release the button.

⚠ CAUTION

- When clipping the file holder onto the metal part of a file or reamer, clip the file holder onto the metal shaft near the handle. Do not clip it onto the cutting part or transition part of the file or reamer. This will cause the file holder to wear out very quickly.

! To make an apex location, use a file or reamer with a plastic handle. If you do not wear gloves, do not use a file with a metal handle. Current leakage from a metal handle to your fingers will prevent an accurate apex location.

! Do not use damaged or worn file holders, otherwise an accurate apex location cannot be made.

Correct

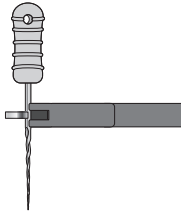

Figure 1

Incorrect

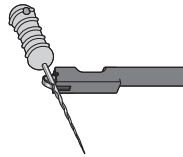

Figure 2

Clip the file or reamer as shown in figure 1.

⚠ CAUTION

- Do not clip them as shown in figure 2. This will prevent accurate apex location and will damage the tip of the file holder.

4 Apex Location (m 1)

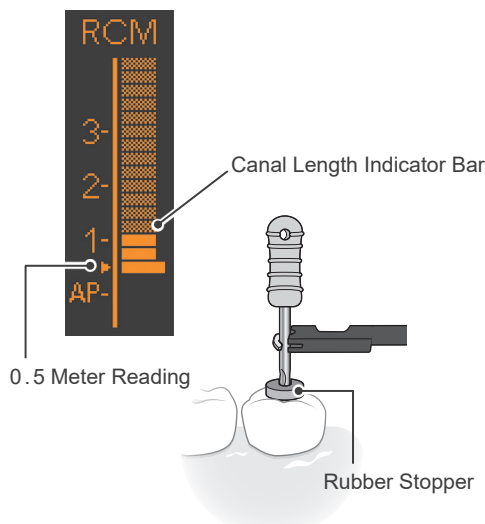

Advance the file down the canal to the 0.5 meter reading point (▶). Then position a rubber stopper on the surface of the tooth or other suitable point to serve as a reference position.

⚠ WARNING

- In some cases such as a blocked root canal, an accurate apex location cannot be made.
 - ☞ p.24 "Root Canals Not Suitable for Electric Apex Location"
- Accurate apex location is not always possible, especially in cases of abnormal or unusual root canal morphology. Make sure to take an X-ray to check the results.
- Stop using the instrument immediately if it does not seem to be working properly.
- If the canal length indicator bar does not appear even when the file is inserted, the instrument may be malfunctioning and must not be used.

- ! Do not touch the gums with the file. The meter will light up all the way.
- ! If the canal is too dry, the meter may not move until the file is near the apex. If the meter does not move, stop the operation. Moisten the canal with oxydol (hydrogen peroxide) or saline, and then try apex location again.
- ! Occasionally the meter will make a sudden and large movement as soon as the file is inserted into the root canal, but it will return to normal as the file is advanced down towards the apex.
- ! After making an apex location, make sure to take an X-ray to check the results.

• 0.5 Meter Reading

The meter's 0.5 reading indicates that the file tip is located very near the physiological apical foramen. Use this to determine the working length depending on the individual case. The exact working length depends on the shape and condition of the canal, and a clinical judgment must be made by the dentist.

* The numerals 1, 2, and 3 do not represent length in millimeters from the apical. These numbers are used to estimate the canal's working length.

5 Turn Power Off



While the standby display is on, you can turn off the instrument by holding down the Select switch (S) and pressing the Main switch (M).

• Auto Power Off Function ☞ p.41 "Auto Power Off Time"

If no switches are pressed for 10 minutes, the instrument will automatically turn off (default setting).

This can usually be done using memories 1 to 4.

Use these four memories to shape canals until you get used to using the Tri Auto ZX2.

1 Turn Power On



Press the Main switch to turn on the instrument.
The stand by display (m1) will appear.

2 Shape Upper Part of Canal (m2)

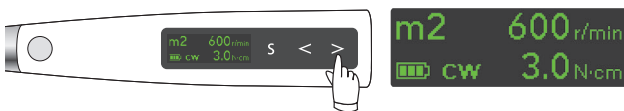

Press the Right-Set switch (➤) to select "m2" (CW mode).
Install a suitable file and shape the upper part of the canal.
Press the Main switch to start and stop the motor.

The torque display appears when the motor is running.
👉 p. 11 "Torque Display"

3 Apex Location (m1)

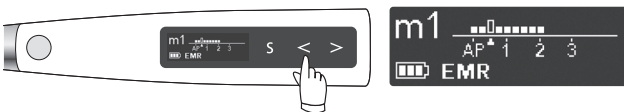

Press the Left-Set switch (➤) to select "m1" (EMR mode) and make an apex location.
👉 p. 18 "Apex Location"

If the contrary electrode is applied to the patient, the instrument can be linked to the apex location function while it is being used.
👉 p. 37 "Settings for Apex Location Linkage"

* The meter numbers 1, 2, and 3 do not represent the actual length from the apical. These numbers are used to estimate the canal's working length.

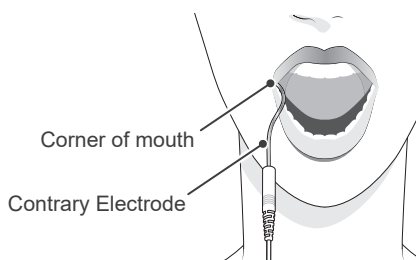

⚠️ WARNING

- Never use an electric scalpel when the contrary electrode is hooked in the patient's mouth. These devices emit electrical noise that could cause the motor to run or cause the device to malfunction.
- Make sure that the contrary electrode, file holder, handpiece file electrode etc., do not come into contact with an electric power source such as a power outlet. This will result in an electric shock.

4 Glide Path (m3)

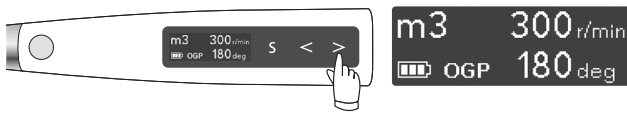

Press the Right-Set switch () to select "m3" (**OGP mode**).
Install a suitable file to perform negotiation and make the glide path.

5 Canal Shaping (m4)

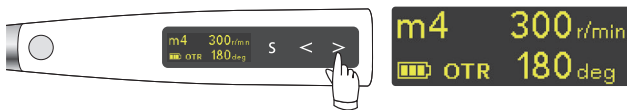

Press the Right-Set switch () to select "m4" (**OTR mode**).
Install a suitable file and shape the canal.
The file will alternate between forward and reverse rotation when the set trigger torque is reached.

6 Turn Power Off



While the standby display is on, you can turn off the instrument by holding down the Select switch (**S**) and pressing the Main switch.

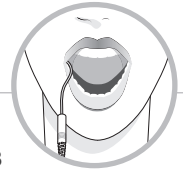

Apex Location Linkage

• Auto Start and Stop Functions p. 38

With the contrary electrode hooked in the patient's mouth, the apex location screen will appear when the file is inserted into the canal. ( p. 11 "Apex location Display") When the canal length indicator bar lights up more than 2 bars, the motor automatically starts rotating. The motor will stop automatically when the file is taken out of the canal and the canal length indicator bar turns off.

* If the canal is dry and prevents the auto start from being triggered, press the Main switch to start the motor.

* If the Tri Auto ZX2 is used without being linked to the apex location function, do not use the contrary electrode and start and stop the motor by pressing the Main switch.

• OAS Function p. 37 "Apical Action"

The file will reverse slightly and stop when it reaches the point where the flash bar has been set.

CAUTION

- The file electrode, contrary electrode, and metal part at the end of the contra angle could cause an adverse reaction if the patient has an allergy to metals. Ask the patient about this before using them.
- Do not touch the oral mucosa or tooth with the metal part at the end of the contra angle. The file could start up and injure the patient or the instrument might not make accurate apex location.
- Be careful when replacing files; the file will start running if the Main switch is pressed.
- Take care that medicinal solutions such as formalin cresol or sodium hypochlorite do not get on the contrary electrode or the contra angle. These could cause an adverse reaction such as inflammation.
- Note that some types of files cannot be used with the file electrode.

Metal part at the end of the contra angle

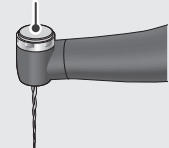

• Auto Power Off Function p. 41 "Auto Power Off Time"

If no switches are pressed for 10 minutes, the instrument will automatically turn off (default setting).

For complex canals such as extremely curved ones or those that may produce ledge formation, use memories m5 to m7 after making the apex location.

1 Turn Power On



Press the Main switch to turn on the instrument.
The stand by display (m1) will appear.

2 Shape Upper Part of Canal (m2)

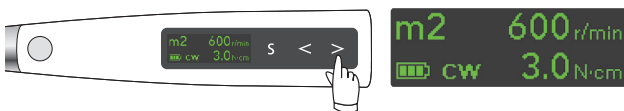

Press the Right-Set switch (➤) to select “m2” (**CW mode**).
Install a suitable file and shape the upper part of the canal.
Press the Main switch to start and stop the motor.

The torque display appears when the motor is running.

👉 p. 11 "Torque Display"

3 Apex Location (m1)

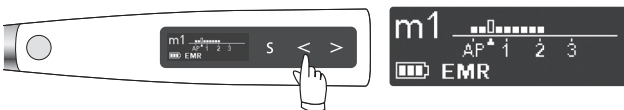

Press the Left-Set switch (➤) to select “m1” (**EMR mode**) and make an apex location.
👉 p. 18 "Apex Location"

If the contrary electrode is applied to the patient, the instrument can be linked to the apex location function while it is being used.

👉 p. 37 "Settings for Apex Location Linkage"

* The numerals 1, 2, and 3 do not represent length in millimeters from the apical. These numbers are used to estimate the canal's working length.

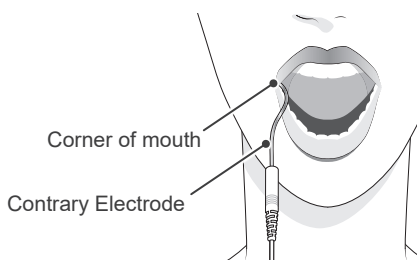

⚠ WARNING

- Never use an electric scalpel when the contrary electrode is hooked in the patient's mouth. These devices emit electrical noise that could cause the motor to run or cause the device to malfunction.
- Make sure that the contrary electrode, file holder, handpiece file electrode etc., do not come into contact with an electric power source such as a power outlet. This will result in an electric shock.

4 Glide Path (m5)

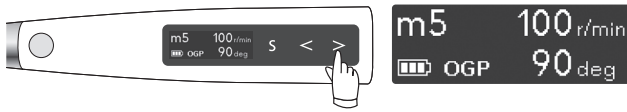

Press the Left-Set switch () to select “m5” (**OGP mode**).
Install a suitable file to perform negotiation and make the glide path.

5 Glide Path (m6)

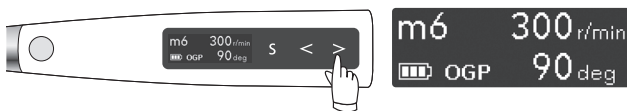

Press the Right-Set switch () to select “m6” (**OGP mode**).
Install a file and make the glide path.

6 Canal Shaping (m7)

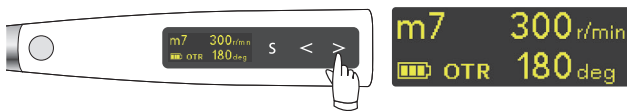

Press the Right-Set switch () to select “m7” (**OTR mode**).
Install a suitable file and shape the canal.
The file will alternate between forward and reverse rotation when the set trigger torque is reached.

7 Turn Power Off



While the standby display is on, you can turn off the instrument by holding down the Select switch (**S**) and pressing the Main switch.



Apex Location Linkage

• Auto Start and Stop Functions p.38

With the contrary electrode hooked in the patient's mouth, the apex location screen will appear when the file is inserted into the canal. ( p.11 "Apex location Display") When the canal length indicator bar lights up more than 2 bars, the motor automatically starts rotating. The motor will stop automatically when the file is taken out of the canal and the canal length indicator bar turns off.

* If the canal is dry and prevents the auto start from being triggered, press the Main switch to start the motor.

* If the Tri Auto ZX2 is used without being linked to the apex location function, do not use the contrary electrode and start and stop the motor by pressing the Main switch.

• OAS Function p.37 "Apical Action"

The file will reverse slightly and stop when it reaches the point where the flash bar has been set.

⚠ CAUTION

- The file electrode, contrary electrode, and metal part at the end of the contra angle could cause an adverse reaction if the patient has an allergy to metals. Ask the patient about this before using them.
- Do not touch the oral mucosa or tooth with the metal part at the end of the contra angle. The file could start up and injure the patient or the instrument might not make an accurate apex location.
- Be careful when replacing files; the file will start running if the Main switch is pressed.
- Take care that medicinal solutions such as formalin cresol or sodium hypochlorite do not get on the contrary electrode or the contra angle. These could cause an adverse reaction such as inflammation.
- Note that some types of files cannot be used with the file electrode.

Metal part at the end of the contra angle

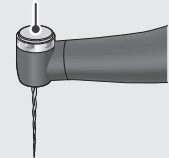

• Auto Power Off Function p.41 "Auto Power Off Time"

If no switches are pressed for 10 minutes, the instrument will automatically turn off (default setting).

Root Canals Not Suitable for Electric Apex Location

Accurate apex location cannot be obtained with the root canal conditions shown below.



Root canal with a large apical foramen

An accurate apex location cannot be obtained if a root canal has an exceptionally large apical foramen due to a lesion or incomplete development. The results may show the apex location shorter than the actual point.

Root canal with blood overflowing from the opening

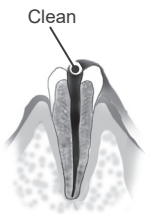

If blood overflows from the opening of the root canal and contacts the gums, this will result in electrical leakage and an accurate apex location cannot be obtained. Wait for bleeding to stop completely. Clean the inside and opening of the canal thoroughly to get rid of all blood, and then check the apex location again.

Root canal with a chemical solution overflowing from the opening

An accurate apex location cannot be obtained if some chemical solution is overflowing from the canal opening. In this case, clean the canal and its opening. It is important to get rid of any solution overflowing the opening.

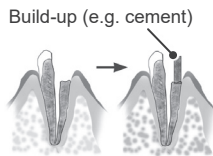

Broken crown

If the crown is broken and a section of the gingival tissue intrudes into the cavity surrounding the canal opening, contact between the gingival tissue and the file will result in electrical leakage and an accurate apex location cannot be obtained. In this case, build up the tooth with a suitable material to insulate the gingival tissue.

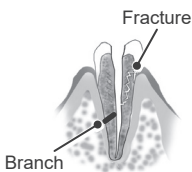

Fractured tooth

Fractured tooth will cause electrical leakage and an accurate apex location cannot be obtained.

A branch canal will also cause electrical leakage.

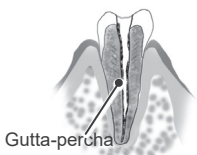

Re-treatment of a root filled with gutta-percha

The gutta-percha must be completely removed to eliminate its insulating effect. After removing the gutta-percha, pass a small file all the way through the apical foramen and then put a little saline in the canal, but do not let it overflow the canal opening.

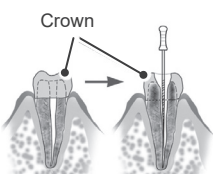

Crown or metal prosthesis touching gingival tissue

Accurate apex location cannot be obtained if the file touches a metal prosthesis that is touching gingival tissue. In this case, widen the opening at the top of the crown so that the file will not touch the metal prosthesis before checking the apex location.

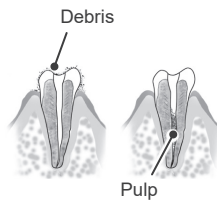

Cutting debris on tooth Pulp inside canal

Thoroughly remove all cutting debris on the tooth.

Thoroughly remove all the pulp inside the canal. Otherwise an accurate apex location cannot be obtained.



Caries touching the gums

In this case, electrical leakage through the caries infected area to the gums will make it impossible to obtain an accurate apex location.



Blocked canal

The meter will not move if the canal is blocked.

Open the canal all the way to the apical constriction to make an apex location.



Extremely dry canal

If the canal is extremely dry, the meter may not move until it is quite close to the apex. In this case, try moistening the canal with oxydol or saline.

■ Tri Auto ZX2 Meter Reading and Radiography

Sometimes the Tri Auto ZX2 meter reading and the X-ray image will not correspond. This does not mean that the Tri Auto ZX2 is not working properly or that the X-ray exposure is a failure. An X-ray image might not show the apex correctly depending on the angle of the X-ray beam, and the location of the apex might seem to be other than it really is.

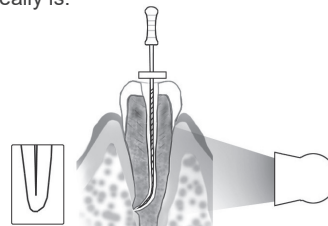

In the illustration to the above, the actual apex for the canal is not the same as that for the anatomical apex. There are frequently cases where the apical foramen is located up towards the crown. In these cases, an X-ray might indicate that the file has not reached the apex even though it has actually reached the apical foramen.

4. After Use

1 Turn Power Off



While the standby display is on, you can turn off the instrument by holding down the Select switch (**S**) and pressing the Main switch.

- **Auto Power Off Function** p.41 "Auto Power Off Time"
If no switches are pressed for 10 minutes, the instrument will automatically turn off (default setting).

2 Take Out the File

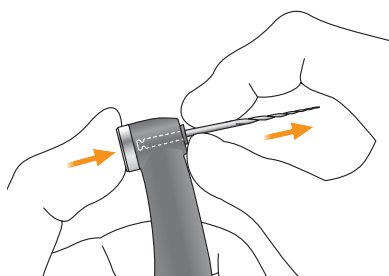

Hold down the push button on the contra angle and pull the file straight out.

CAUTION

- Be careful when inserting and removing files to avoid injury to fingers.
- Inserting and removing files without holding the push button may damage the chuck.
- Take care not to touch the Main switch when removing the file. This will cause the file to rotate.

3 Remove HP Protective Sleeve

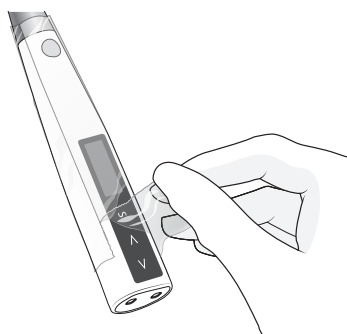

Remove the protective sleeve and throw it away.

- * A new protective sleeve must be used for each patient. (Never reuse.)

WARNING

- To prevent cross contamination between patients, use a new sleeve for each patient. (Never reuse.)

4 Battery Charging

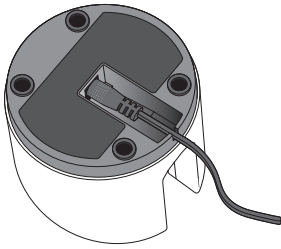

Plug the DC end of the adapter cable all the way into the bottom of the charger, and plug the other end into a power outlet. The Ready LED (green) will light up.

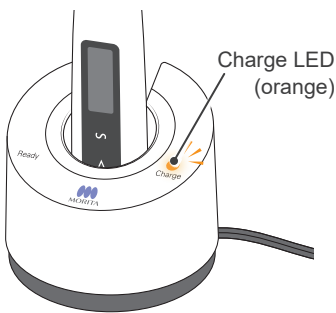

Put the handpiece all the way into the battery charger. The Ready LED (green) will go out and the Charge LED (orange) will light up and start charging the handpiece.

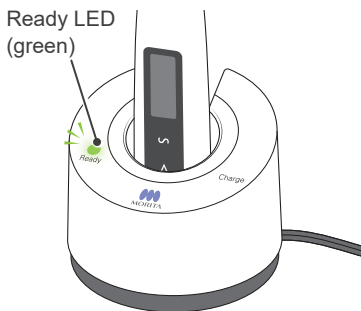

When the battery is fully charged, the Charge LED (orange) goes out and the Ready LED (green) will light up.

* The battery is inside the motor handpiece.

⚠ WARNING

- Always use the adapter that comes with the Tri Auto ZX2. Using another adapter can result in electric shocks, malfunctions, fires, etc.
- The charger and its adapter must be located at least 2 meters away from the patient.
- Do not use the battery charger for any device except the Tri Auto ZX2.

* It takes about 100 minutes to fully charge the battery.

⚠ WARNING

- Do not touch the battery charger or AC adapter if there is lightning while the battery is being charged. This will result in an electric shock.
- Do not use the battery charger in a place where it might get wet.

⚠ CAUTION

- Do not charge the handpiece with the probe cord connected or wrapped around the handpiece. This could break a wire inside the cord or damage the jack.
- There is a magnet inside the charger and this could attract metal clips etc. If this happens simply remove the metal clip etc.

- ❗ If the Charge LED (orange) goes off immediately or doesn't light up when the handpiece is put into the charger, the battery is already fully charged. To make sure, take the handpiece out and put it back in again.
- ❗ Make sure there is no dirt, metal fragments etc. on the connection contacts for both the handpiece end and the battery charger. If the contacts are dirty, wipe them with a piece of gauze dampened with ethanol (70 vol% to 80 vol%) after thoroughly wringing it out first. Pay attention to avoid bending or deforming the connection contacts.
- ❗ Do not leave the battery charger where it will be exposed to direct sunlight.
- ❗ Unplug the battery charger when it is not being used.

Residual Battery Power

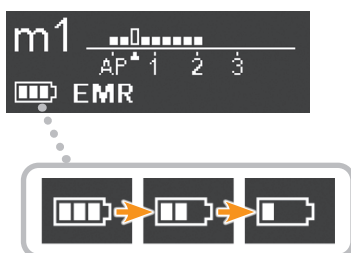

The number of bars show how much power is left.

If "Low Battery" appears in the display screen, the residual power is at a very low level. Charge the battery immediately if the instrument does not return to the standby display when the Main switch is pressed.

Low Battery Please Charge p. 50 "2. Abnormal Stop"

- ❗ Charge the battery as soon as the indicator gets down to only one bar.

Using and handling the power plug for the AC Adapter.

The main plug for the AC adapter is not connected when the Tri Auto ZX2 is shipped. Four types of plugs are provided as shown below. Select the one suitable for your region.

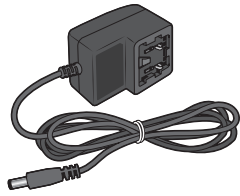

AC adapter

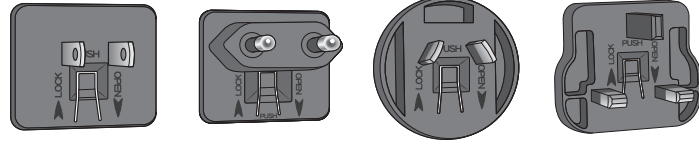

Power Plugs

• Connect Power Plug

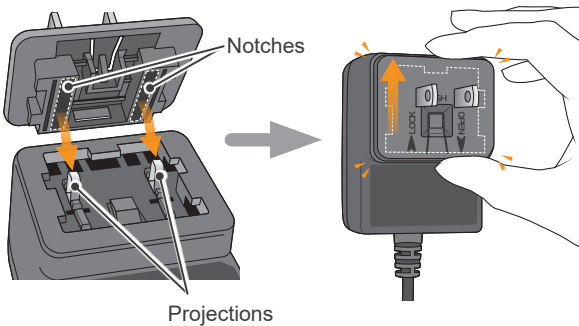

Match the notches in the power plug with the projections in the AC adapter and push it in the LOCK direction (arrow pointing up) until it clicks into place.

⚠ WARNING

- Make sure the power plug is properly and securely installed.
- Never plug in a power plug alone without installing it. This will result in an electric shock.

• Disconnect Power Plug

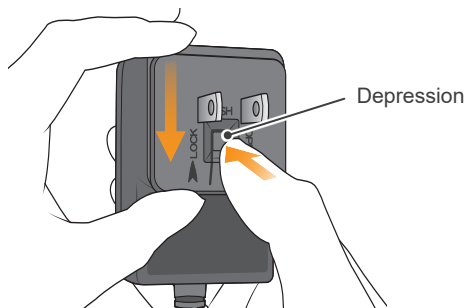

Press down on the depression in the center of the power plug and slide it in the OPEN direction (arrow pointing down)

5. Reprocessing

There are two ways to perform reprocessing depending on the items.

Parts to be Sterilized

📖 p. 29



Contra Angle

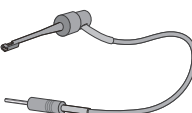

File Holder



Contrary Electrodes



Handpiece Holder



External File Electrode (with cap)



Long File Holder

Parts to be Disinfected

📖 p. 33



Motor Handpiece

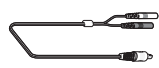

Probe Cord

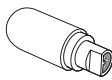

Tester



Battery Charger



Guide Bar

⚠️ WARNING

- To prevent the spread of infections, be sure to perform the reprocessing procedures after use with each patient.
- Be careful to avoid cross infection when performing reprocessing.
- Always wear personal protective equipment (PPE) such as safety glasses, gloves, a mask, etc. when performing the reprocessing procedures.

⚠️ CAUTION

- When performing reprocessing, always turn off the device and make sure that the device will not operate.
- Be careful when clipping and unclipping files to avoid injury to fingers.

- ❗ After use, perform reprocessing promptly.
- ❗ Before reprocessing, make sure that all the parts (e.g., file, file holder, etc.) are separated individually.

■ Preparation

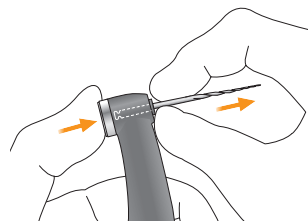
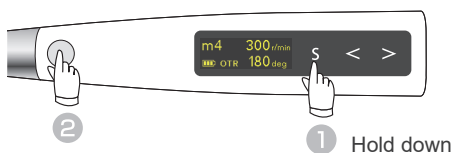

Turn off the power.
Disconnect all parts.
📖 p. 25 "4. After Use"

Parts to be Sterilized

Be sure to perform the reprocessing procedures in the following order promptly after use with each patient.



* Only the contra angle needs to be lubricated.

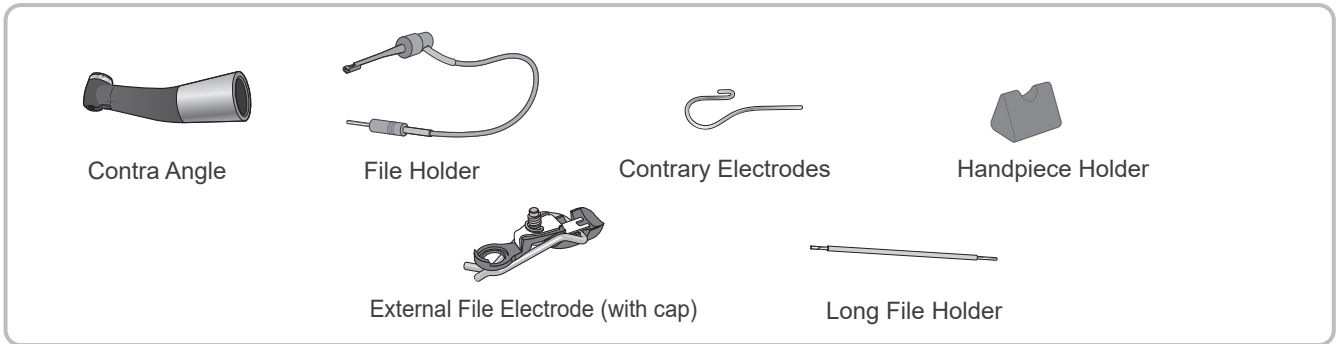

Pre-treatment

This must be performed after use with each patient.

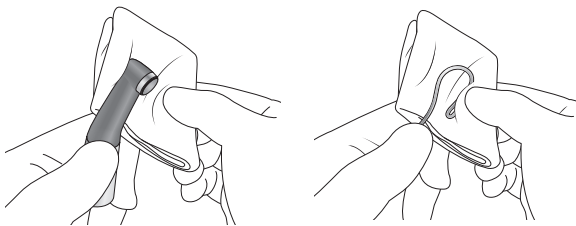

Wipe the parts with a piece of gauze or microfiber cloth (e.g., Toraysee for CE - Medical Equipment and Instruments Maintenance Cloth) that has been dampened with tap water to remove visible contaminants.



Alternatively, clean the parts in running water with a soft brush to remove visible contaminants.

CAUTION

- Before reprocessing the contra angle, do not fail to take out the file.

- ! After use, perform reprocessing promptly. If the parts are left contaminated with blood, it will be difficult to remove.
- ! Do not use any chemicals that may coagulate proteins before cleaning.
- ! If a medical agent being used for the treatment has adhered to the part, wash it off under tap water.
- ! Be careful not to tug on the cord when you clean the file holder. This could cause the wire to break.



- ! Do not clean the parts with an ultra sonic cleaning device.
- ! If dust or other impurities enter the contra angle, they may cause poor rotation.

Cleaning & Disinfection

Put parts in the parts washing basket.
(For the contra angle, set it in a handpiece holder.)

Select the washer-disinfector's mode as shown in the chart and start the process.



Recommended Conditions for Washer-Disinfectors

Unit Name	Miele G 7881
Mode	Vario TD
Detergent (concentration)	neodisher MediClean (0.3% to 0.5%)
Rinse (concentration)	neodisher MediKlar (0.02% to 0.04%)

* After cleaning there may be streaks or white spots on the parts. Use a neutralizer only if there are streaks or white spots.

After completing the cleaning process, make sure the parts are thoroughly clean.

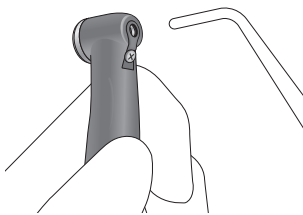

Expel remaining moisture on the surface or inside the parts with compressed air.

WARNING

- If any moisture is left inside the parts after cleaning, it could cause corrosion or poor sterilization. Also, the remaining water may come out during use. After cleaning, use a syringe or compressed air to expel remaining moisture.

CAUTION

- Dust and other impurities adhering to the file holder's electrical contacts or hook can cause the device to malfunction.



- ! Be sure to remove visible contaminants before this step.
- ! Be sure to use washer-disinfectors that conform to ISO 15883-1 (must be capable of achieving disinfection values of not less than $A_0 = 3000$).
- ! If your region is susceptible to hard water scale buildup, use deionized water (ion-exchanged water).
- ! For details on handling detergents and neutralizers, concentration, water quality as well as parts washing baskets, refer to the accompanying user manual for the washer-disinfector.
- ! Inappropriate cleaning methods and solutions may damage the parts.
- ! Do not use strong acidic or alkaline chemicals that could cause the metal to corrode.
- ! Do not start drying when the interior of the part is filled with water. Otherwise, this could result in corrosion of the part due to condensation of the rinsing solution.
- ! After completing the cleaning process, expel remaining moisture inside the parts with compressed air.
- ! Do not leave the parts in the washer-disinfector. This may cause corrosion or malfunction of the parts.
- ! Parts' surface may get scratched and wear out during the cleaning process due to contact with the parts washing basket or other parts. Replace the parts as necessary depending on degree of scratches and wear.
- ! Always use a handpiece holder when washing the contra angle, making sure to rinse the inside of the contra angle thoroughly.
- ! Always lubricate the contra angle after washing.

Lubrication

* Only the contra angle needs to be lubricated.

* Lubrication and excess oil removal can be performed by J. MORITA's dental handpiece maintenance device.

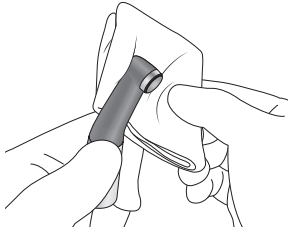

(1) Cover the contra angle with a piece of gauze or other suitable cloth.

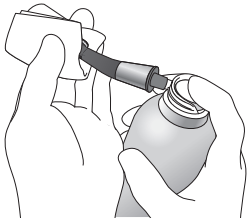

(2) Screw the nozzle onto the spray can. Then insert it into the connection end of the contra angle, and spray for 2 seconds. Use gauze etc. to wipe excess spray off the outside of the contra angle.

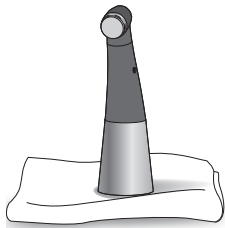

(3) Stand the contra angle up on a piece of gauze to allow all the excess spray to drain out.

Before autoclaving, the contra angle must be lubricated with the MORITA MULTI SPRAY.

⚠ CAUTION

- Do not use any type of spray other than the MORITA MULTI SPRAY.
- Failure to lubricate the contra angle will result in a malfunction.

⚠ WARNING

- Prevent spray from splashing into your eyes etc. by always covering the contra angle with gauze or suitable cloth.

⚠ WARNING

- Never direct the spray towards a person.
- Never use the spray near an open flame.
- Hold both the contra angle and the spray can firmly when using the spray. Otherwise, the pressure of the spray could make the contra angle fly out of your hand.

⚠ CAUTION

- Always shake the spray can two or three times before using it. Use the can in an upright position.

⚠ CAUTION

- The motor handpiece could be damaged if the contra angle is attached without allowing the excess spray to drain out first.

Packing

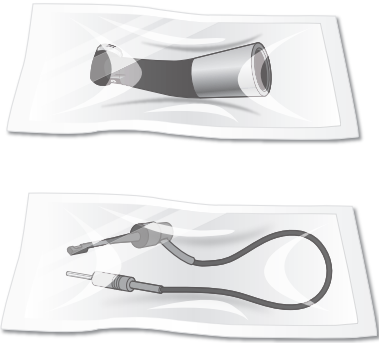

Place the parts individually in a sterilization pouch.
Use only FDA-cleared pouches. (for U.S.A.)

- ! Use sterilization pouches that conform to ISO 11607.
- ! Do not use any sterilization pouches that contain hydrosoluble adhesive ingredients such as PVA (polyvinyl alcohol). Otherwise, its adhesive ingredient may elute, seep into the contra angle during the sterilization, resulting in a solid residue and a failure to rotate properly. Note that even ISO 11607 conformable sterilization pouches may contain PVA.
- ! When placing a part in a sterilization pouch, be sure not to put stress on the part (e.g., cord).

Sterilization

Autoclave the autoclavable parts.
After autoclaving, store the parts in a clean and dry environment.

135 °C



Recommended Autoclave Settings

Country : U.S.A.

Sterilizer type	Temperature	Time	Drying time after sterilization
Gravity	+ 132 °C (+ 269.6 °F)	15 minutes	15 minutes
	+ 121 °C (+ 249.8 °F)	30 minutes	

Country : Other than U.S.A.

Sterilizer type	Temperature	Time	Drying time after sterilization
Dynamic Air Removal	+ 134 °C (+ 273.2 °F)	3 minutes	10 minutes
	+ 134 °C (+ 273.2 °F)	5 minutes	
Gravity	+ 134 °C (+ 273.2 °F)	min. 6 minutes	min. 10 minutes
	+ 121 °C (+ 249.8 °F)	min. 60 minutes	

! WARNING

- To prevent the spread of infections, the parts must be autoclaved after each patient's treatment has been completed.

! CAUTION

- Parts are extremely hot right after autoclaving. Wait for them to cool off before touching.

- ! Do not sterilize the parts by any method other than autoclaving.
- ! If chemical solutions or foreign debris are not removed, autoclaving could damage or discolor the part. Thoroughly clean and sterilize the parts before autoclaving.
- ! The setting temperature for sterilization and drying process must be +135 °C (+275 °F) or lower. If the temperature is set at beyond +135 °C (+275 °F), it may cause a malfunction or stain on the parts.
- ! Do not autoclave any parts other than the contra angle, file holder, contrary electrode, handpiece holder, external file electrode (with cap) and long file holder.
- ! Take the file out of the file holder before autoclaving.
- ! Follow the manufacturer's recommendations for autoclaving files.
- ! After completing the autoclaving process, do not leave the parts in the autoclave.
- ! Do not fail to lubricate the contra angle with the spray before autoclaving it.

Parts to be Disinfected

Be sure to perform the reprocessing procedures in the following order promptly after use with each patient.

Pre-treatment → Cleaning & Disinfection



Motor Handpiece



Battery Charger

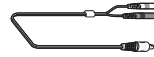

Probe Cord

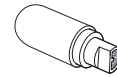

Tester

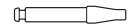

Guide Bar

Pre-treatment

This must be performed after use with each patient.

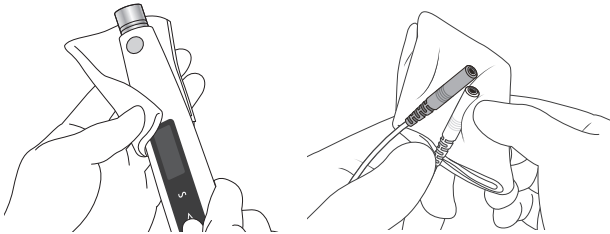

Wipe the parts with a piece of gauze or microfiber cloth (e.g., Toraysee for CE - Medical Equipment and Instruments Maintenance Cloth) that has been dampened with tap water to remove visible contaminants. Then wipe off moisture completely with a soft cloth.

- ❗ After use, perform reprocessing promptly. If the parts are left contaminated with blood, it will be difficult to remove.
- ❗ Do not use any chemicals that may coagulate proteins before cleaning.
- ❗ If a medical or adhesive agent being used for the treatment has adhered to the part, immediately remove it with a piece of gauze or microfiber cloth (e.g., Toraysee for CE - Medical Equipment and Instrument Maintenance Cloth) that has been dampened with tap water.
- ❗ Be sure not to tug on the cable when you clean the parts. This could cause the wire to break.



- ❗ Do not clean the parts with an ultra sonic cleaning device.
- ❗ Do not wet the electrical contacts.

Cleaning & Disinfection

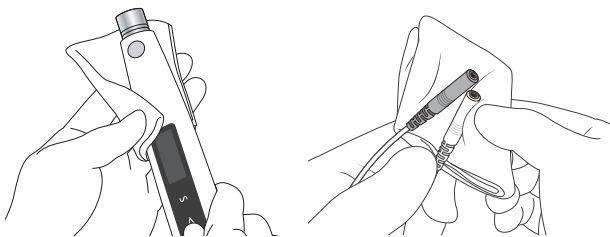

Wipe the part's surface with disinfectants approved by J. MORITA MFG. CORP.

Disinfectants Approved by J. MORITA MFG. CORP.

Disinfectant	Country
Ethanol (70 vol% to 80 vol%)	U.S.A.
Opti-Cide 3 (wipes)	
FD 366 sensitive (wipes)	Other than U.S.A.

- ❗ Make sure that there is no visible moisture and contamination when wiping the parts.
- ❗ Be sure not to tug on the cable when you clean the parts. This could cause the wire to break.
- ❗ Do not use disinfectants other than those designated by J. MORITA MFG. CORP.
- ❗ For details on handling disinfectants, refer to the accompanying user manual for each disinfectant.
- ❗ If too much disinfectant is applied to the piece of gauze or microfiber cloth, it will seep into the part and cause a malfunction.
- ❗ Do not immerse the parts in or wipe them with any of the following: functional water (acidic electrolyzed water, strong alkaline solution, and ozone water), medical agents (glutaral, etc.), or any other special types of water or commercial cleaning liquids. Such liquids may result in metal corrosion or adhesion of the residual medical agent to the parts.
- ❗ Do not clean or immerse the parts with chemicals such as formalin cresol (FC) and sodium hypochlorite. These will damage the metal and plastic parts. Immediately wipe away any chemicals that are accidentally spilled on the parts.

How to Make Various Settings

Rotation Controls

The Tri Auto ZX2 has the rotation controls listed below. These controls can be assigned to each memory.

! Some functions cannot always be used or set depending on the operation mode and other settings for various functions.

Function	Description	Setting Method
Operation Mode	5 operation modes for canal shaping and apex location.	p. 35
Speed	File rotation speed.	p. 36
Torque (Torque Limit / Trigger Torque)	For CW and CCW modes, the torque value (Torque Limit) that triggers reverse rotation. For OTR mode, the torque value (Trigger Torque) that triggers OTR action. For CW and CCW modes, also R.L (torque reverse less) can be set.	
Apical Action	The file action when file tip reaches the flash bar point.	p. 37
Auto Start	The file rotation starts automatically when the file is inserted in the canal.	p. 38
Auto Stop	The file rotation stops automatically when the file is taken out of the canal.	
Flash Bar Position	Shows the point inside the canal where specified apical action is triggered.	
Apical Slow Down (Apical Slow Dwn.)	The file slows down automatically as it approaches the apex.	p. 39
Torque Slow Down (Torq. Slow Dwn.)	The file slows down automatically as the torque loads increases.	
Apical Torque Down (Apical Torq. Dwn.)	Torque limit automatically decreases as the file approaches the apex.	p. 40
Rotation Angle	For OTR and OGP modes, this shows the arcs for forward and reverse rotation.	
Beeper Volume	Volume of beeping for indicating the position inside the canal, torque reverse etc.	

■ Default Memory Settings

The default memory settings are listed below. These settings can be changed as needed.

Setting Item	m 1	Normal Canals			Complex Canals			m 8	Setting Method
		m 2	m 3	m 4	m 5	m 6	m 7		
Function	Apex Location	Upper Part Shaping	Glide Path	Canal Shaping	Glide Path	Glide Path	Canal Shaping	Inject Medicinal Solutions	
Operation Mode	EMR	CW	OGP	OTR	OGP	OGP	OTR	CCW	p. 35
Speed (r/min)	N/A	600	300	300	100	300	300	200	p. 36
Torque Limit (N•cm)	N/A	3.0	N/A	N/A	N/A	N/A	N/A	R.L	
Trigger Torque (N•cm)	N/A	N/A	N/A	0.2	N/A	N/A	0.2	N/A	
Apical Action	N/A	OAS	OAS	OAS	OAS	OAS	OAS	Off	p. 37
Auto Start	N/A	Off	On	On	On	On	On	Off	p. 38
Auto Stop	N/A	Off	On	On	Off	Off	Off	Off	
Flash Bar Position	▲	1	▲	1	▲	▲	1	▲	
Apical Slow Down	N/A	Off	N/A	N/A	N/A	N/A	N/A	Off	p. 39
Torque Slow Down	N/A	Off	N/A	N/A	N/A	N/A	N/A	Off	
Apical Torque Down	N/A	Off	N/A	N/A	N/A	N/A	N/A	Off	p. 40
Rotation Angle (OGP mode)	N/A	N/A	180	N/A	90	90	N/A	N/A	
Rotation Angle (OTR mode)	N/A	N/A	N/A	180	N/A	N/A	180	N/A	
Beeper Volume	Vol. 3	Vol. 3	Vol. 3	Vol. 3	Vol. 3	Vol. 3	Vol. 3	Vol. 3	

Set Operation Mode

Operation Mode

1 Turn Power On

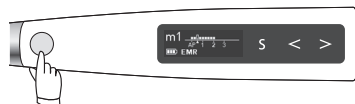

Press the Main switch to turn on the instrument.

2 Select Memory Number



Press the Set switches (**<** **>**) to select a memory from m1 to m8.

3 Show Setting Display



Hold down the Select switch (**S**) for 1 second or more.
Operation Mode will display.

m3 Operation Mode
OGP

4 Select Operation Mode



Press Set switches (**<** **>**) to select an operation mode.

5 Return to Standby Display



Press the Main switch to return to the standby display. Or simply wait until the instrument automatically goes back to the standby display.

■ Operation Mode Settings

Operation Mode

m3 Operation Mode
OGP

There are 5 modes for canal shaping and apex location.

EMR : Apex location

CCW : Reverse rotation only. Used to inject calcium hydroxide and other solutions.

* When this mode is being used, a double-beep sounds continuously.

CW : Normal 360° forward rotation. Torque reverse and other functions can be used.

OTR : Used for canal shaping.

OGP : Used for negotiation and making glide paths.

Set Speed and Torque

Speed (r/min)

Torque (N·cm)

1 Turn Power On



Press the Main switch to turn on the instrument.

2 Select Memory Number



Press the Set switches (◀ ▶) to select a memory from m1 to m8.

3 Show Setting Display



Hold down the Select switch (S) for 1 second or more. Operation Mode will display.

m3 Operation Mode
OGP

4 Select and Set Functions

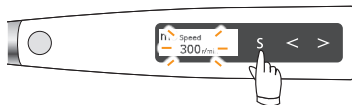

Press the Select switch (S) until the desired function appears. Press the Set switches (◀ ▶) to make the setting.

5 Return to Standby Display



Press the Main switch to return to the standby display. Or simply wait until the instrument automatically goes back to the standby display.

Speed and Torque Settings

Speed (r/min)

m3 Speed
300 r/min

This is the file rotation speed.

- Possible speed settings for various modes.

EMR	CW (forward)	CCW (reverse)	OTR	OGP
N/A	100 150 200 250 300 400 500 600 800 1000		100 300 500	

Torque (N·cm)

m2 Torque Limit
3.0 N·cm

For CW and CCW modes, the torque value (Torque Limit) that triggers reverse rotation. For OTR mode, the torque value (Trigger Torque) that triggers OTR action. For CW and CCW modes, also R.L (torque reverse less) can be set.

For EMR and OGP modes, Torque Limit and Trigger Torque value cannot be set.

* In CCW mode, the motor only runs in reverse and does not change rotation direction even when it reaches the set torque limit. The beeping sound changes to alert the user when Torque Limit has been reached.

- Possible Torque Limit Values

CW (forward)	CCW (reverse)
0.2 0.4 0.6 0.8 1.0 1.5 2.0 2.5 3.0 4.0 5.0 R.L	

If Torque Slow Down or Apical Torque Down is turned on, 0.2 N·cm and R.L (torque reverse less) cannot be selected.

- Possible Trigger Torque Values

OTR
0.2 0.4 0.6 0.8 1.0

CAUTION

- If the instrument is set for R.L (torque reverse less), the motor will not reverse rotation no matter how large the torque load is.
- Match the torque setting to the canal and file.

! There is some discrepancy in the torque value depending on condition of the motor and contra angle and this value is used only as a reference.

Settings for Apex Location Linkage

Apical Action

Auto Start

Auto Stop

Flash Bar Position

1 Turn Power On



Press the Main switch to turn on the instrument.

2 Select Memory Number



Press the Set switch (**S**) to select a memory from m1 to m8.

3 Show Setting Display



Hold down the Select switch (**S**) for 1 second or more. Operation Mode will display.

m3 Operation Mode
OGP

4 Select and Set Functions



Press the Select switch (**S**) until the desired function appears. Press the Set switches (**<** **>**) to make the setting.

5 Return to Standby Display



Press the Main switch to return to the standby display. Or simply wait until the instrument automatically goes back to the standby display.

■ Settings

Apical Action

m3 Apical Action
OAS

Actions that happen automatically when the file tip reaches the point inside the canal determined by the Flash Bar setting.

☞ p.38 "Flash Bar Position"

Off : Rotation continues as before without stopping or reversing.

Stop **Auto Apical Stop**
: File stops automatically.

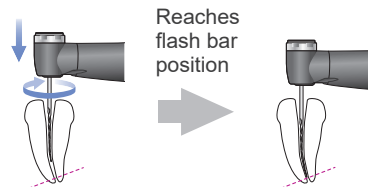

Reverse **Auto apical Reverse**
: File automatically reverses rotation.

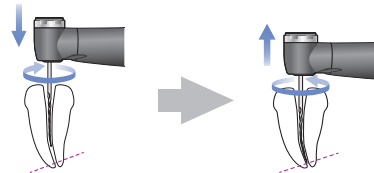

OAS **Optimum Apical Stop**
: Automatically reverses slightly (1/2 to 1 rotation) and then stops after file jamming is freed.

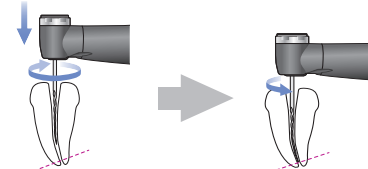

• Possible apical action settings for various modes.

EMR	CW (forward)	CCW (reverse)	OTR	OGP
N/A	<p>Off Stop</p> <p>Re-verse OAS</p>	<p>Off Stop</p> <p>OAS</p>	<p>Off Stop</p> <p>Re-verse OAS</p>	<p>Off Stop</p> <p>Re-verse OAS</p>

Auto Start

m3 Auto Start
On

Rotation starts automatically when the file is inserted into the canal and the canal length indicator bar lights up more than 2 bars.

On : Motor starts automatically.

Off : Motor does not start when file is inserted into the canal.
The Main switch is used to start and stop the motor.

• Possible Auto Start on/off settings for various modes.

EMR	CW (forward)	CCW (reverse)	OTR	OGP
N/A	<input type="radio"/> On <input type="radio"/> Off			
If Auto Stop is turned on, this cannot be turned off.				

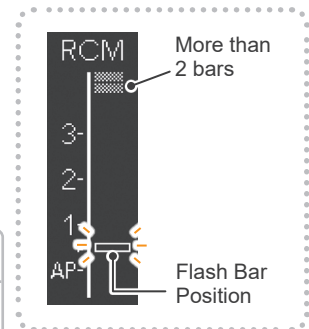

Auto Stop

m3 Auto Stop
On

Rotation stops automatically when the file is taken out of the canal and the canal length indicator bar turns off.

On : Motor stops automatically.

Off : Motor does not stop when file is taken out.
The Main switch is used to start and stop the motor.

• Possible Auto Stop on/off settings for various modes.

EMR	CW (forward)	CCW (reverse)	OTR	OGP
N/A	<input type="radio"/> On <input type="radio"/> Off			
If Auto Start is turned off, this cannot be turned on.				

! The auto stop function works only if the motor was started with the auto start function.
It will not work if the motor was started with the Main switch even if it is turned on.

Flash Bar Position

m3 Flash Bar Position
AP 1 2 3

This is the point where various apical actions are triggered.

▲ The meter's 0.5 reading indicates that the file tip is located very near the physiological apical foramen.

The flash bar can be set from 2 to AP (Apex) on the meter.

EMR	CW (forward)	CCW (reverse)	OTR	OGP
Setting Range: <input type="radio"/> AP (Apex) – <input type="radio"/> 2				

Set Other Functions

Apical Slow Down

Torque Slow Down

Apical Torque Down

Rotation Angle

Beeper Volume

1 Turn Power On



Press the Main switch to turn on the instrument.

2 Select Memory Number



Press the Set switch (**S**) to select a memory from m 1 to m 8.

3 Show Setting Display



Hold down the Select switch (**S**) for 1 second or more. **Operation Mode** will display.

m3 Operation Mode
OGP

4 Select and Set Functions

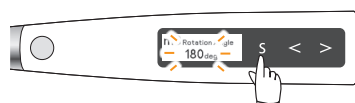

Press the Select switch (**S**) until the desired function appears. Press the Set switches (**<** **>**) to make the setting.

5 Return to Standby Display



Press the Main switch to return to the standby display. Or simply wait until the instrument automatically goes back to the standby display.

■ Settings

Apical Slow Down

m2 Apical Slow Dwn.
Off

Rotation automatically slows down as the file tip approaches the apex.

On : Automatically slows down.

Off : Does not slow down.

- Possible apical slow down settings for various modes.

EMR	CW (forward)	CCW (reverse)	OTR	OGP
N/A	<p style="text-align: center;">On Off</p>		N/A	N/A
If Apical Torque Down is turned on, this cannot be turned on.				

Torque Slow Down

m2 Torq. Slow Dwn.
Off

Rotation automatically slows down as the torque load on the file increases.

On : Automatically slows down.

Off : Does not slow down.

- Possible torque slow down settings for various modes.

EMR	CW (forward)	CCW (reverse)	OTR	OGP
N/A	<p style="text-align: center;">On Off</p>		N/A	N/A
If Apical Torque Down is turned on or the torque is set for 0.2 or R.L (torque reverse less), this cannot be turned on.				

Apical Torque Down

m2 Apical Torq. Dwn.
Off

The torque limit automatically decreases as the file approaches the apex.

On : Automatically decreases.

Off : Does not change.

- Possible Apical Torque Down settings for various modes.

EMR	CW (forward)	CCW (reverse)	OTR	OGP
N/A	<div style="display: flex; justify-content: space-around;"> On Off </div>		N/A	N/A
If Apical Slow Down or Torque Slow Down is turned on or the torque is set for 0.2 or R.L (torque reverse less), this cannot be turned on.				

Rotation Angle

m3 Rotation Angle
180deg

For OGP and OTR modes, this shows the arcs for forward and reverse rotation.

OGP Mode

- OGP (Optimum Glide Path) Function

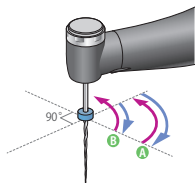

* Illustration is for 90 setting.

Repeat the watch-winding (A) and balanced force (B) motions.

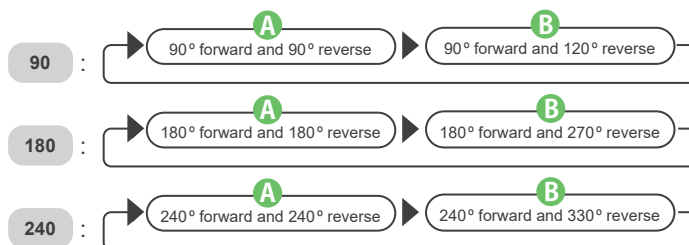

OTR Mode

- OTR (Optimum Torque Reverse) Function

Normal Rotation

OTR Action

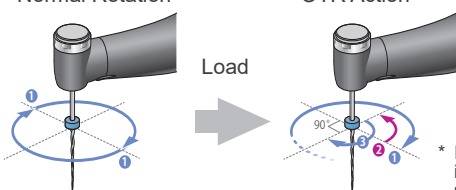

* Illustration is for 180 setting.

Continuous forward rotation as normal and the load on the file is checked every 180° rotation (1). When the load on the file exceeds the set limit, the file automatically starts alternating between reverse 90° (2) and 180° forward rotation (3). (Both forward and reverse angles are default settings.)

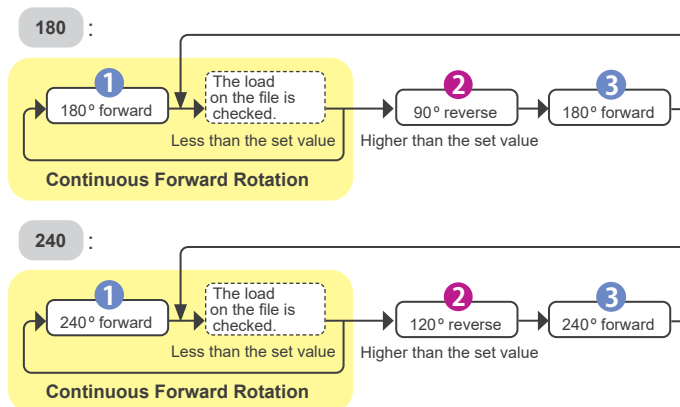

- Possible rotation angle settings for various modes.

EMR	CW (forward)	CCW (reverse)	OTR	OGP
N/A	N/A	N/A	180 240	90 180 240

Beeper Volume

m2 Beeper Volume
Vol.3

Volume of beeping for indicating the position inside the canal, torque reverse etc.

Vol. 0 : Off, **Vol. 1** : Soft, **Vol. 2** : Medium, **Vol. 3** : Loud

EMR	CW (forward)	CCW (reverse)	OTR	OGP
<div style="display: flex; justify-content: space-around;"> Vol. 0 Vol. 1 Vol. 2 Vol. 3 </div>				

Other Handpiece Functions

In addition to the rotation control functions, the Tri Auto ZX2 has the following functions as well. These settings are common for all memories.

■ Default Handpiece Settings

The default settings are listed below. These settings can be changed as needed.

Auto Power Off (Auto Power Off Time)	Auto Standby Scr. (Auto Return to Standby Display)	Dominant Hand	Startup Memory (Startup Memory Number)
10 min	10 sec	Right	m 1

Set Handpiece Functions

1 Turn Power On

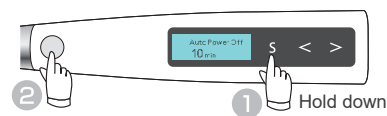

With the instrument turned off, hold down the Select switch (**S**) and press the Main switch to turn on the instrument. The Auto Power Off Time display will appear.

2 Select and Set Functions

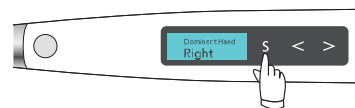

Press the Select switch (**S**) until the desired function appears. Press the Set switches (**<** **>**) to make the setting.

3 Return to Standby Display

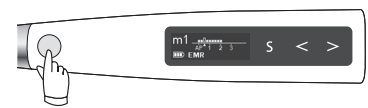

After making the setting, press the Main switch to return to the standby display.

■ Settings

Auto Power Off Time

Auto Power Off
10 min

This shows how long it takes for the instrument to shut itself off if no switches are pressed.

It can be set from 1 to 30 minutes in 1 minute increments. **1 min** – **30 min**

Auto Return to Standby Display

Auto Standby Scr.
10 sec

This shows how long it takes for the instrument to go back to the standby display if no switches are pressed.

It can be set from 1 to 15 seconds in 1 second increments. **3 sec** – **15 sec**

Dominant Hand

Dominant Hand
Right

This will rotate the display direction 180°.

Set this for right or left depending on the user's dominant hand. **Right** or **Left**

Startup Memory Number

Startup Memory
m1

This sets the memory number that appears right after the instrument is turned on.

m1 : Memory m 1 will appear when the instrument is turned on.

Previous : The memory being used when the instrument was turned off will appear.

Reset Memories to Original Default Settings

All memories and handpiece settings will revert to their original default settings.

* All memories (m 1 to m 8) and handpiece functions will be initialized.
It is not possible to initialize just one of them.

1 Turn Power On

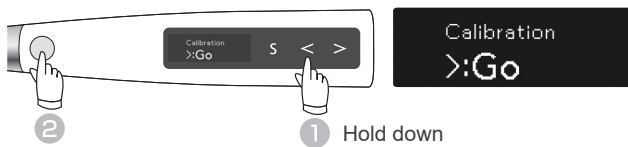

With the instrument turned off, hold down the Left-Set switch () and then press the Main switch. The calibration display will appear.

2 Select Display

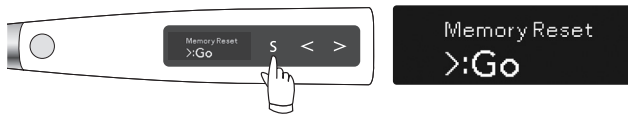

Press the Select switch () and select the Memory Reset.

3 Reset Memory



Press the Right-Set switch () to reset the memories to their default settings. After the memories are reset, the instrument will automatically return to the standby display.

Replacement Parts

- * Replacement parts and consumable parts are described in the Regular Inspection List. Replace the parts as necessary depending on degree of wear and length of use.
- * Order parts from your local dealer or J. MORITA OFFICE.

Replacing Battery

Replace the battery if it seems to be running out of power sooner than it should. The battery will last for approximately 1 year under normal circumstances and use. (This depends somewhat on how the instrument is used and ambient conditions such as humidity.)

(1) Turn the power off.

- ! Do not leave the power on when disconnecting the battery.

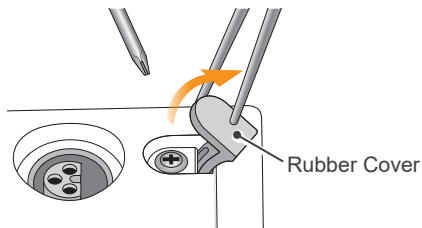

(2) Use tweezers etc. to open the rubber cover and then remove the screw.

- ! Open the rubber cover carefully. Don't pull too hard. It might come off the motor handpiece.
- ! Do not remove the battery cover if the handpiece is wet.

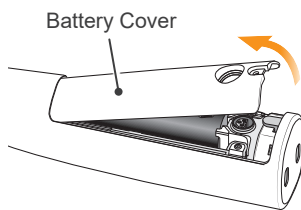

(3) Remove the battery cover as shown in the illustration.

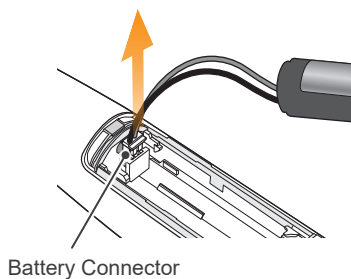

(4) Remove the old battery and disconnect the connector.

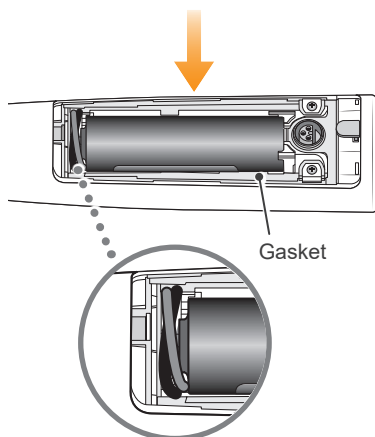

(5) Connect the new battery and put it in the motor handpiece.

⚠ CAUTION

- Use only the battery designed for the Tri Auto ZX2. Other batteries could cause overheating.
- Do not use a battery if it is leaking, deformed, discolored or if its label is peeled off. It might overheat.

- ! Wind the cable in a ring and put it away as shown in the illustration. Stuffing it in haphazardly could make it hard to close the cover or result in a broken wire.

(6) Replace the cover and its screw.

- ! Do not tighten the cover screw too much. This could strip the threads.
- ! Dispose of old batteries (Lithium-ion batteries) in an environmentally safe way and in strict accordance with local regulations.
- ! Do not put the cover on if the gasket is not properly in place. The cover could be loose and liquids might seep inside.

Replacing Built-in Electrode

If the canal length indicator bars flicker during use, or if all the bars in the meter do not light up when the file touches the contrary electrode, and cleaning the rotor axle and built-in electrode does not solve the problem, then the built-in electrode is worn out and must be replaced with a new one according to the following procedure.

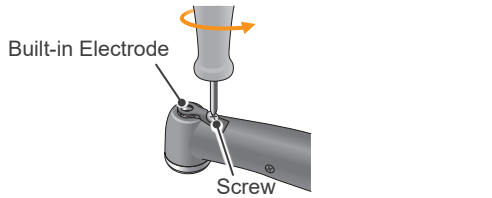

(1) Loosen the screw and remove the built-in electrode.

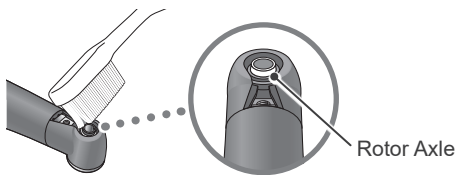

(2) Put a little ethanol (70 vol% to 80 vol%) on a brush and clean the rotor axle with it.

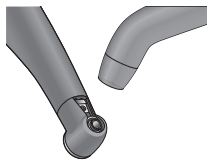

(3) Blow air on the electrode to remove any remaining moisture.

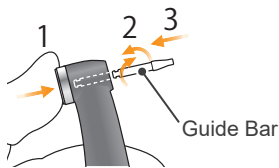

(4) Hold down the push button, insert the guide bar and turn it back and forth until it fits into the latch groove. Then release the push button to secure the bar.

⚠ CAUTION

- Always use the guide bar and make sure it will not come out. If the guide bar cannot be properly fixed in place, the internal contact could be bent, and then the instrument might not be able to make an accurate apex location or else it might malfunction.
- Do not run the motor with the guide bar inserted. This could damage the instrument.

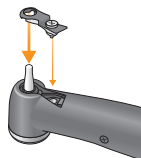

(5) Slide the built-in electrode onto the guide bar and line up the screw holes.

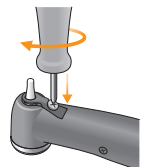

(6) Slowly turn the screw and make sure the built-in electrode goes into the head properly.

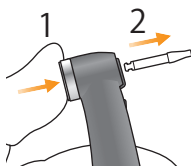

(7) Tighten the screw securely and then hold down the push button and pull out the guide bar.

⚠ WARNING

- Make sure the screw is tight enough. Otherwise, it might come out and be swallowed. Also, the apex location might not be accurate.

Contact is too high.

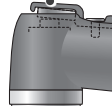
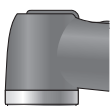

Correct

Incorrect

(8) Make sure the cap is properly placed.

(9) Autoclave the contra angle.

👉 p.29 "Parts to be Sterilized"

External File Electrode

If you use a file that cannot make an apex location with the built-in electrode, replace it with external file electrode (sold separately).

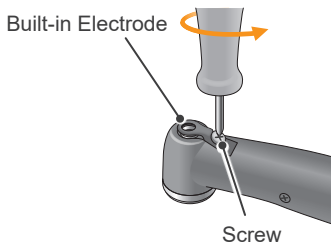

(1) Loosen the screw and remove the built-in electrode.

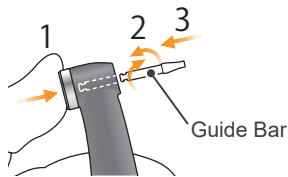

(2) Hold down the push button, insert the guide bar and turn it back and forth until it fits into the latch groove. Then release the push button to secure the bar.

⚠ CAUTION

- Always use the guide bar and make sure it will not come out. If the guide bar is not properly fix in place, the internal contact could be bent, and then the instrument might not be able to make accurate apex location or else it might malfunction.
- Do not run the motor with the guide bar inserted. This could damage the instrument.

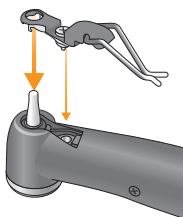

(3) Slide the external file electrode onto the guide bar and line up the screw holes.

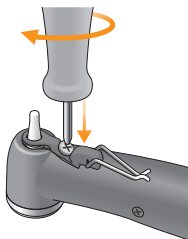

(4) Slowly turn the screw and make sure the cap goes into the head properly.

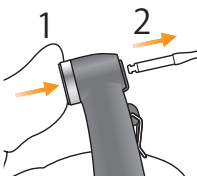

(5) Tighten the screw securely and then hold down the push button and pull out the guide bar.

⚠ WARNING

- Make sure the screw is tight enough. Otherwise, it might come out and be swallowed. Also, the apex location might not be accurate.

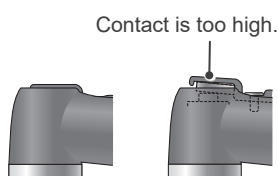

(6) Make sure the cap is properly placed.

Correct Incorrect

(7) Autoclave the contra angle.

 **p.29 "Parts to be Sterilized"**

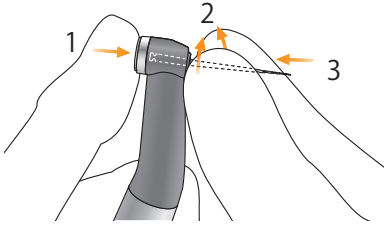

- (8) Hold down the push button on the contra angle and insert the file.
Turn the file back and forth until it is lined up with interior latch groove and slips into place. Release the button to lock the file into the contra angle.

* Use only Ni-Ti or properly designed stainless steel files.

⚠ WARNING

- Make sure the file is all the way in. Give it a light tug to make sure it is held securely.
- Never use stretched, deformed or damaged files.

⚠ CAUTION

- Be careful when inserting and removing files to avoid injury to fingers.
- Never put file in or take it out without pressing the button down. This could damage the chuck. Always hold the button down to put a file in or take it out.
- Do not use files with shanks larger than the ISO standard.
ISO Standard: $\varnothing 2.334$ to 2.350 mm

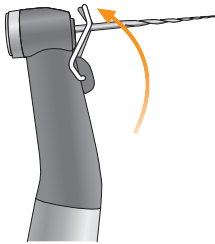

- (9) Lift the electrode up and clip it onto the file.

⚠ WARNING

- Always clip the electrode on the file when using it. Otherwise, the apex location may not be accurate or rotation may not be properly controlled. (It may not be possible to make an accurate apex location if blood or some other liquid overflows the canal or if the canal is completely blocked.)

⚠ CAUTION

- Do not let the cutting part of the file touch the electrode. Otherwise the file electrode will wear out very quickly.
- Some files cannot be used with this electrode.
- Also the Ni-Ti files noted below cannot be used. To use these types of files, do not clip on the electrode and use the motor in manual mode.
 - Those with a file diameter of more than 1.2 mm.
 - Those with chuck shanks that are not perfectly round.
 - Gates-Glidden Drills
 - Those that have cutting sections with large diameters such as largo burs.

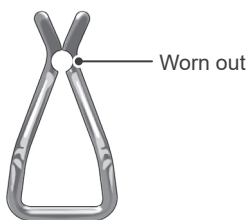

⚠ WARNING

- Replace the external file electrode if it is worn out as shown in the photo to the left.



Maintenance and Inspection

■ Regular Inspection

* Maintenance and inspection are generally considered to be the duty and obligation of the user, but if, for some reason, the user is unable to carry out these duties, they may be performed by the accredited service personnel. Contact your local dealer or J. MORITA OFFICE for details.

* Consumable and replacement parts are described in page 53.

* This instrument should be inspected every 6 months in accordance with the following maintenance and inspection items.

- Connect the AC adapter to the battery charger, plug it in and check that the Ready LED (green) lights up.
- Make sure there is no dirt, metal fragments etc. on the connection contacts for both the motor handpiece end and the battery charger.
- Put the motor handpiece into the battery charger and check that the Charge LED (orange) lights up. Check that the battery does not seem to be losing its charge too quickly.
- Check that the connection end of the motor handpiece is not damaged or dirty.
- Check that the connection end of the contra angle is clean and not damaged and that it can be properly connected to the motor handpiece.
- Check that the push button works and a file can be properly installed.
- Check that the external file electrode (option) clips onto the file properly and that it is not worn or damaged.
- Check that the instrument turns on when the Main switch is pressed, and that the instrument turns off when the Select switch is held down and the Main switch is pressed.
- Press the Set switch ( ) to select a memory from m 1 to m 8.
- Check that the settings for each of the memories can be changed.
- Visually inspect the probe cord and its plugs and connectors carefully and make sure that they are not damaged or dirty.
- Make sure the probe cord connector goes into its motor jack properly.
- Visually inspect the file holder and contrary electrode to make sure that they are not damaged or dirty.
- Make sure the file holder plug fits properly into its probe connector (gray).
- Make sure the file holder holds a file properly.
- Make sure the contrary electrode fits properly into its probe connector (white).
- Contact the file with the contrary electrode and check that all the root canal length indicator bars on the display are lit.
- Connect the tester and make sure the meter reads within 2 bars above or below bar 1 on the meter.
- Press the Main switch and make sure that this starts and stops the motor.
- Run the motor in OGP mode, and check that it changes rotation direction.
- Run the motor in CW mode and make sure the torque meter changes according to the load on the file.

* For repairs contact your local dealer or J. MORITA OFFICE.

■ Useful Life

The useful life of the Tri Auto ZX2 is 6 years from the date of installation provided it is regularly and properly inspected and maintained. The useful life is set based on the useful life of the electronic components used in this unit.

■ Standards and Procedures for the Disposal of Medical Devices

The dentist or doctor responsible for the patient's treatment must confirm that a medical device is uncontaminated, and must then have it disposed of by a healthcare facility or an agent licensed and qualified to handle standard industrial waste and industrial waste requiring special treatment.

The rechargeable battery should be recycled. Metal parts of the equipment are disposed as scrap metal. Synthetic materials, electrical components, and printed circuit boards are disposed as electrical scrap. Material must be disposed according to the relevant national legal regulations. Consult specialized disposal companies for this purpose. Please inquire of the local city/community administrations concerning local disposal companies.

Troubleshooting

1. Troubleshooting

If the instrument does not seem to be working properly, the user should first try to inspect and adjust it himself.

* If the user is unable to inspect the instrument himself or if the instrument fails to work properly after being adjusted or after parts are replaced, contact your local dealer or J. MORITA OFFICE.

Problem	Check Points	Remedies	Ref.
No power.	Check the battery power.	Charge the battery.	p. 26
	Check the battery installation.	Install the battery properly.	p. 43
	Degraded battery.	Replace the battery.	
Display does not appear.	Is there a sound when the instrument is turned on and off?	Charge battery if there is no sound. Broken display if there is a sound.	p. 26
Motor handpiece does not run.	Is it set for EMR mode?	Select a mode other than EMR mode.	p. 35
No sound.	Beep volume set to 0?	Set beep volume to 1, 2, or 3.	p. 40
Beep sound an alarm even though the instrument is not being used.	Is the instrument set to CCW (reverse rotation) mode?	When set to CCW mode, the beeper sounds an alarm after a set time period elapses. If this is annoying, set the beeper sound for 0.	
Motor does not run when the file is inserted in the canal.	Is contrary electrode properly hooked in the corner of the patient's mouth?	Hook the contrary electrode in the corner of the patient's mouth.	p. 18
	Is the instrument set to EMR mode?	Select a mode other than EMR mode.	p. 35
	Is auto start turned off?	Turn the auto start function on.	p. 38
	Does the canal length indicator bar light up only 1 bar or it does not light up?	Advance the file down the root canal, or add some moisture such as saline solution to the canal to light up 2 bars or more.	p. 38
	Does the fixing screw for the built-in electrode or external file electrode loose?	Tighten the screw securely.	p. 13
	Is the external file electrode worn out?	Replace the external file electrode with a new one.	p. 45
Motor stops too easily.	Does the canal length indicator bar light up?	Advance the file down the root canal, or add some moisture such as saline solution to the canal to light up 1 bar or more.	p. 38
	Does the fixing screw for the built-in electrode or external file electrode loose?	Tighten the screw securely.	p. 13
	Is the external file electrode worn out?	Replace the external file electrode with a new one.	p. 45
Motor spontaneously starts running in reverse.	Torque limit may be set.	Set the Torque Reverse function for R.L (torque reverse less) if this is not desired.	p. 36
	Is the apical action setting on reverse?	Change the Apical Action setting to Off or Stop.	p. 37
	Is the instrument set to CCW (reverse rotation) mode?	Change rotation mode to something other than CCW (reverse rotation) mode.	p. 35
Motor reverse its rotation too easily.	Torque limit value might be set too low.	Increase the torque limit value.	p. 36
	The Apical Torque Down function might be turned on.	The torque limit automatically decreases as the file approaches the apex. To use a fixed reverse torque value, turn the Apical Torque Down function off.	p. 40
	Does the canal retain some blood or chemical solution?	In that case, the apex location meter could indicate a large movement and reach the flash bar. Advance the file down the root canal so that the meter display will resume in the appropriate position and the file rotation will return to the forward direction.	p. 19

Problem	Check Points	Remedies	Ref.
Motor does not reverse its rotation.	Set for R.L (torque reverse less)?	Change this to something other than R.L (torque reverse less).	p. 36
	Torque reverse setting might be too high.	Lower the torque reverse setting.	
	Apical Action might be turned off.	Set Apical Action to Reverse.	p. 37
	Is Apical Action setting "Stop" or "OAS"?	Set Apical Action to Reverse.	
Motor changes speed spontaneously.	Apical Slow Down might be turned on.	Rotation slows down as file approaches the apex. For a steady rotation speed, turn it off.	p. 39
	Torque Slow Down might be turned on.	Rotation slows down as file torque increases. For a steady rotation speed, turn it off.	
Instrument turns off by itself.	Instrument might not have been used for a while.	Auto Power Off was triggered. Press the Main switch to turn on the instrument again.	p. 41
	Momentary large load when battery is low?	If pressing the Main switch returns to standby display but the battery is low, charge the battery.	p. 50
Apex location meter is unstable.	Does the built-in electrode need replacement? Has it been replaced recently?	<ul style="list-style-type: none"> Clean and lubricate the contra angle. Remove the internal electrode and clean it and the rotor axle with a brush. Replace the built-in electrode. 	p. 44
	Does the fixing screw for the built-in electrode or external file electrode loose?	Tighten the screw securely.	p. 13
	Is the external file electrode worn out?	Replace the external file electrode with a new one.	p. 45
Motor alternates between forward and reverse rotation.	Is it set to OTR mode?	In OTR mode, rotation alternates between forward and reverse if the torque is greater than the specified value.	p. 40
	Is it set to OGP mode?	In OGP mode, the motor always alternates between forward and reverse.	
	Does alternating rotation happen even after calibration?	Raise the trigger torque 1 level.	p. 38
Cannot make an apex location.	Is the contrary electrode properly hooked in the corner of the patient's mouth?	Hook the contrary electrode in the corner of the patient's mouth.	p. 18
	Does the file or reamer lack electrical conductivity between the shank and the file?	Use a file or reamer that has conductivity or use the external file electrode.	p. 45
	A wire in the probe cord might be broken.	Touch the white connector on the probe cord with the gray one and see if all the bars on the meter light up.	N/A
Battery cannot be charged.	Does the Ready LED (green) light up?	Check the AC adapter is connected correctly.	p. 26
		Make sure the AC adapter that comes with the Tri Auto ZX2 is used. If any other AC adapter that is not dedicated to the Tri Auto ZX2 is connected, the battery charger could be damaged.	
	Does the Charge LED (orange) light up when putting the motor handpiece into the battery charger?	<p>If the motor handpiece is nearly fully charged, LED indicators will change as below.</p> <p>1. The Ready LED (green) turns off.</p> <p>↓</p> <p>2. The Charge LED (orange) lights up for a brief second, then goes out.</p> <p>↓</p> <p>3. The Ready LED (green) lights up.</p> <p>If the motor handpiece is not fully charged, put it back into the charger again. If the Charge LED (orange) still does not light up, contact your local dealer or J. MORITA OFFICE.</p>	

2. Abnormal Stop

The motor handpiece may stop working in the 4 cases listed below.

Display	Cause	Remedies
Error 01 <small>See Operation manual</small>	Control circuits may have malfunctioned.	Turn the instrument off and then back on again. If the error message appears again, stop using the instrument immediately and contact your local dealer or J. MORITA OFFICE. The number that appears after "Error" depends on the malfunction. ☞ p.50 "3. Error Numbers"
Low Battery <small>Please Charge</small>	Battery power is very low or the motor was subjected to a very large load momentarily.	Normally, press the Main switch to return to the Standby display. If the instrument does not return to the Standby display when the Main switch is pressed or if the message reappears after returning to the Standby display, the battery is very low and must be recharged. ☞ p.26 "Battery Charging" However, if the Standby display does not appear while a file is in the canal, take the file out and then press the Main switch.
Overload <small>Motor Stop</small>	This appears if the motor is subjected to a large load constantly such as when the file is locked in the canal and the motor cannot rotate.	Normally, press the Main switch to return to the Standby display. If the instrument does not return to the Standby display when the Main switch is pressed the battery is very low and must be recharged. ☞ p.26 "Battery Charging" However, if the Standby display does not appear while a file is in the canal, take the file out and then press the Main switch.
Overload <small>Sudden Power Off</small>	If the motor was subjected to a very large load momentarily and the battery does not have enough power, the instrument will turn off automatically. When the instrument is turned back on, the message shown to the left appears in the screen.	If pressing the Main switch returns to the Standby display but the battery is low, charge the battery. ☞ p.26 "Battery Charging"

3. Error Numbers

If an error or problem is detected, the instrument will stop and an error number will appear in the display.

If the instrument stops, turn it off and then back on again. If the error message appears again, stop using the instrument and contact your local dealer or J. MORITA OFFICE.

Make a note of the error number and report it when requesting assistance.

Error No.	Problem	Error No.	Problem
01	Battery power detection fault	65	EEPROM fault
04	Motor fault	66	Apex location fault
08	Torque settings fault	96	Watch dog fault
16	Internal buffer fault		

Technical Specifications

* Specifications may be changed without notice due to improvements.

Name	Tri Auto ZX2
Model	TR-ZX2
Degree of Protection against Ingress of Water	IPX0
Indications for Use	The Tri Auto ZX2 device is a cordless endodontic treatment motorized handpiece with apex location capability. It can be used to enlarge the canals while monitoring the position of the file tip inside the canal. It can be used as a low-speed motorized handpiece and device for making the apex location.
Operating Principle	By electric drive, it transmits motion, such as rotation and vibration, to treatment instruments (dental files, reamers, etc.). The impedance in the root canal is calculated by determining the differences at two frequencies which is then used to indicate the position of the treatment instruments in the root canal.
Essential Performance	None (There is no unacceptable risk.)

Handpiece

Free Running Operation Speed	100 ±20 – 1000 ±100 r/min
Gear Ratio	1.9 : 1
Usable Burs	Type 1 (CA)
Rated Torque	min. 4 N•cm
Chuck Type	Push button latch type
Root Apex Location Accuracy	-1.5 – +0.5 mm (+: Apex side, -: Crown side) According to JIS T 5751
Protection against Electric Shock	Internal powered ME equipment / Type BF applied part
Battery	Lithium ion battery (DC 3.7 V)
Dimensions	Approx. Dia. 31 × Length 202 mm (including contra angle and motor handpiece)
Weight	Approx. 140 g (including contra angle and motor handpiece)
Applied Part	Contra angle, Motor handpiece, File holder, Contrary electrode

Battery Charger

Rated Input Voltage	DC 5 V
Rated Input Current	2.4 A
Dimensions	Approx. Dia. 86 × Height 72 mm
Weight	Approx. 280 g

AC Adapter

Rated Input Voltage	AC 100 – 240 V
Rated Input Frequency	47 – 63 Hz
Rated Input Current	0.4 A
Classification of Protection against Electric Shock	Class II

Symbols

* Some symbols may not be used.



CE (0197) marking
Conforms with the European Directive, 93/42/EEC.
CE marking
Conforms with the European Directive, 2011/65/EU.



WEEE directive marking



Direct current



Serial number



Unique device identifier



Medical device



Type BF applied part



Never reuse



Supports high-temperature cleaning and disinfection



Autoclavable up to +135°C (+275°F)



Manufacturer



Date of manufacture



EU Authorized Representative under the European Directive 93/42/EEC



GS 1 DataMatrix



Fragile



Keep away from rain



Temperature limitation



This way up



Atmospheric pressure limitation



Humidity limitation



Refer to instructions for use

Non-Sterile

Sterilize components before use

Rx Only

Caution:
Federal law restricts this device to sale by or on the order of a dentist.(for U.S.A.)



Authorized representative in Switzerland





Service Contacts

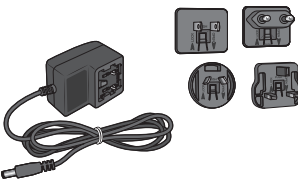
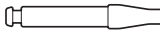
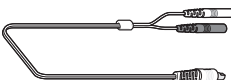
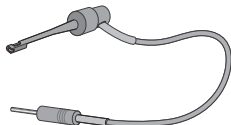

The Tri Auto ZX2 may be repaired and serviced by

- The technicians of J. MORITA's subsidiaries worldwide.
- Technicians employed by authorized J. MORITA dealers and specially trained by J. MORITA.
- Independent technicians specially trained and authorized by J. MORITA.

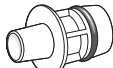
For repairs or other types of service, contact your local dealer or J. MORITA OFFICE.

Consumable and Replacement Parts

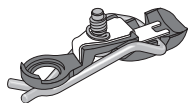
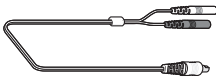
Battery (1) Code No. 7505628 	AC Adapter (1) Code No. 8456097 	Built-in Electrode (with guide bar) (1) Code No. 8491887 	Guide Bar (1) Code No. 8491763 
Probe Cord (0.75 m) (1) Code No. 8456062 	File Holder (5) Code No. 7503670 	Contrary Electrode (5) Code No. 7503680 	Tester (1) Code No. 8456089 
HP Protective Sleeve Type A (box of 100) Code No. 8456070 	SPRAY Nozzle (1) Code No. 7503970 	MORITA MULTI SPRAY (1) Code No. 7914113 or 5010201 	

Handpiece Holder (1) Code No. 9181504 	External File Electrode (with cap and guide bar) (1) Code No. 8491879 	Probe Cord (1.8 m) (1) Code No. 8449422 	Long File Holder (5) Code No. 8447055 
--	--	---	--

Electromagnetic Disturbances (EMD)

The Tri Auto ZX2 (hereafter “this device”) conforms to IEC 60601-1-2:2014 Ed. 4.0, the relevant international standard for electromagnetic disturbances (EMD).

The following is the “Guidance and Manufacturer’s Declaration” which is required by IEC 60601-1-2:2014 Ed. 4.0, the relevant international standard for electromagnetic disturbances.

This is a Group 1, Class B product according to EN 55011 (CISPR 11).

This means that this device does not generate and/or use internationally radio-frequency energy, in the form of electromagnetic radiation, inductive and/or capacitive coupling, for the treatment of material or inspection/analysis purpose and that it is suitable for use in domestic establishments and in establishments directly connected to a low voltage power supply network which supplies buildings use for domestic purposes.

Guidance and Manufacturer’s Declaration – Electromagnetic Emissions		
This device is intended for use in the electromagnetic environment specified below. The customer or the user of this device should assure that it is used in such an environment.		
Emissions Test	Compliance	Electromagnetic Environment – Guidance
Conducted disturbance CISPR 11	Group 1 Class B	This device uses RF energy only for its internal function. Therefore, its RF emissions are very low and are not likely to cause any interference in nearby electronic equipment.
Radiated disturbance CISPR 11	Group 1 Class B	This device is suitable for use in all establishments, including domestic establishments and those directly connected to the public low-voltage power supply network that supplies buildings used for domestic purposes.
Harmonic current ¹ IEC 61000-3-2	Class A	
Voltage fluctuations and flicker IEC 61000-3-3	Clause 5	

¹: Although this device is not applicable to Harmonics test since the rated power is less than 75 W, it has been tested as a reference according to limits for Class A.

WARNING

- The use environment of this device is the Home healthcare environment.
- This device needs special precautions regarding EMD and needs to be installed and put into service according to the EMD information provided in the ACCOMPANYING DOCUMENTS.
- Use of parts other than those accompanied or specified by J. MORITA MFG. CORP. could result in increased electromagnetic emissions or decreased electromagnetic immunity of this device and result in improper operation.
- Do not use this device as adjacent or stacked as possible with other. When adjoining or stacking is necessary, use it after observing whether this equipment and other equipment work properly.
- Portable and mobile RF communications equipment (including peripherals such as antenna cables and external antennas) should be used no closer than 30 cm to any part of the TR-ZX2, including cables specified by the manufacturer.

Guidance and Manufacturer’s Declaration – Electromagnetic Immunity			
This device is intended for use in the electromagnetic environment specified below. The customer or the user of this device should assure that it is used in such an environment.			
Immunity Test	IEC 60601 Test Level	Compliance Level	Electromagnetic Environment – Guidance
Electrostatic discharge (ESD) IEC 61000-4-2	±8 kV contact ±2 kV, ±4 kV, ±8 kV, ±15 kV air	±2 kV, ±4 kV, ±6 kV, ±8 kV contact ±2 kV, ±4 kV, ±8 kV, ±15 kV air	Floors should be wood, concrete or ceramic tile. If floors are covered with synthetic material, the relative humidity should be at least 30%.
Electrical fast transients/bursts IEC 61000-4-4	±2 kV for power supply lines ±1 kV for input/output lines	±2 kV for power supply lines ¹ ±1 kV for input/output lines ¹	Mains power quality should be that of a typical commercial or hospital environment.
Surge IEC 61000-4-5	<u>AC/DC power</u> ±0.5 kV, ±1 kV line(s) to line(s) ±0.5 kV, ±1 kV, ±2 kV line(s) to earth <u>Signal input/output</u> ±2 kV line(s) to earth	<u>AC/DC power</u> ±0.5 kV, ±1 kV line(s) to line(s) ±0.5 kV, ±1 kV, ±2 kV line(s) to earth <u>Signal input/output</u> ² ±2 kV line(s) to earth	Mains power quality should be that of a typical commercial or hospital environment.
Voltage dips, short interruptions and voltage variations on power supply lines IEC 61000-4-11	<u>dips</u> 0% U_T : 0.5 cycle (at 0, 45, 90, 135, 180, 225, 270, 315°) 0% U_T : 1 cycle (at 0°) 70% U_T : 25/30 cycles (at 0°) 25 (50 Hz)/30 (60 Hz) <u>short interruptions</u> 0% U_T : 250/300 cycles 250 (50 Hz)/300 (60 Hz)	<u>dips</u> 0% U_T : 0.5 cycle (at 0, 45, 90, 135, 180, 225, 270, 315°) 0% U_T : 1 cycle (at 0°) 70% U_T : 25/30 cycles (at 0°) 25 (50 Hz)/30 (60 Hz) <u>short interruptions</u> 0% U_T : 250/300 cycles 250 (50 Hz)/300 (60 Hz)	Mains power quality should be that of a typical commercial or hospital environment. If user of this device requires continued operation during power mains interruptions, it is recommended that this device be powered from an uninterruptible power supply or a battery.
Power frequency (50/60 Hz) magnetic field IEC 61000-4-8	30 A/m (r.m.s.) 50 Hz or 60 Hz	30 A/m (r.m.s.) 50 Hz or 60 Hz	Power frequency magnetic field should be at levels characteristic of a typical location in a typical commercial or hospital environment.
NOTE 1: U_T is the a.c. mains voltage prior to application of the test level. NOTE 2: r.m.s.: root mean square			

¹: This test is not applicable since the EUT signal cable is less than 3 m.

²: Not applicable because it does not connect directly to outdoor cable.

Guidance and Manufacturer's Declaration – Electromagnetic Immunity			
This device is intended for use in the electromagnetic environment specified below. The customer or the user of this device should assure that it is used in such an environment.			
Immunity Test	IEC 60601 Test Level	Compliance Level	Electromagnetic Environment – Guidance
Conducted RF IEC 61000-4-6	3 V ISM ^(c) / amateur radio frequency band: 6 V 150 kHz to 80 MHz	3 V ISM ^(c) / amateur radio frequency band: 6 V 150 kHz to 80 MHz	Portable and mobile RF communications equipment should be used no closer to any part of this device, including cables, than the recommended separation distance calculated from the equation applicable to the frequency of the transmitter.
Radiated RF IEC 61000-4-3	10 V/m 80 MHz to 2.7 GHz 27 V/m 385 MHz 28 V/m 450 MHz 9 V/m 710, 745, 780 MHz 28 V/m 810, 870, 930, MHz 28 V/m 1720, 1845, 1970 MHz 28 V/m 2450 MHz 9 V/m 5240, 5500, 5785 MHz	10 V/m 80 MHz to 2.7 GHz 27 V/m 385 MHz 28 V/m 450 MHz 9 V/m 710, 745, 780 MHz 28 V/m 810, 870, 930, MHz 28 V/m 1720, 1845, 1970 MHz 28 V/m 2450 MHz 9 V/m 5240, 5500, 5785 MHz	Recommended separation distances $d = 1.2\sqrt{P}$ 150 kHz to 80 MHz $d = 0.4\sqrt{P}$ 80 MHz to 800 MHz $d = 0.7\sqrt{P}$ 800 MHz to 2.7 GHz $d = \frac{6}{E} \sqrt{P}$ Portable wireless RF communication equipment Where P is the maximum output power rating of the transmitter in watts (W) according to the transmitter manufacturer, E is the compliance level in V/m and d is the recommended separation distance in meters (m). Field strengths from field RF transmitters, as determined by an electromagnetic site survey ^(a) , should be less than the compliance level in each frequency range ^(b) . Interference may occur in the vicinity of equipment marked with the following symbol: 
NOTE 1: At 80 MHz and 800 MHz, the higher frequency range applies. NOTE 2: These guidelines may not apply in all situations. Electromagnetic propagation is affected by absorption and reflection from structures, objects and people.			
<p>^(a) Field strengths from fixed transmitters, such as base stations for radio (cellular/cordless) telephones and land mobile radios, amateur radio, AM and FM radio broadcast and TV broadcast cannot be predicated theoretically with accuracy. To assess the electromagnetic environment due to fixed RF transmitters, an electromagnetic site survey should be considered. If the measured field strength in the location in which this device is used exceeds the applicable RF compliance level above, this device should be observed to verify normal operation. If abnormal performance is observed, additional measures may be necessary, such as reorienting or relocating this device.</p> <p>^(b) Over the frequency range 150 kHz to 80 MHz, field strengths should be less than 3 V/m.</p> <p>^(c) The ISM (Industrial, Scientific and Medical) bands between 0.15 MHz and 80 MHz are 6.765 MHz to 6.795 MHz; 13.553 MHz to 13.567 MHz; 26.957 MHz to 27.283 MHz; and 40.66 MHz to 40.70 MHz. The amateur radio bands between 0.15 MHz and 80 MHz are 1.8 MHz to 2.0 MHz, 3.5 MHz to 4.0 MHz, 5.3 MHz to 5.4 MHz, 7 MHz to 7.3 MHz, 10.1 MHz to 10.15 MHz, 14 MHz to 14.2 MHz, 18.07 MHz to 18.17 MHz, 21.0 MHz to 21.4 MHz, 24.89 MHz to 24.99 MHz, 28.0 MHz to 29.7 MHz and 50.0 MHz to 54.0 MHz.</p>			

Essential Performance

None

Cable List

No.	Interface(s):	Max. Cable Length, Shielding	Cable Classification
1.	DC Power Cable	1.8 m, Un-shielded	DC Power Line
2.	Probe Cord	1.8 m, Un-shielded	Signal Line (Patient-Coupled Cable)



Development and Manufacturing

J. MORITA MFG. CORP.

680 Higashihama Minami-cho, Fushimi-ku, Kyoto 612-8533, Japan
T +81. (0)75. 611 2141, F +81. (0)75. 622 4595

Morita Global Website
www.morita.com

Distribution

J. MORITA CORP.

3-33-18 Tarumi-cho, Suita-shi, Osaka 564-8650, Japan
T +81. (0)6. 6380 1521, F +81. (0)6. 6380 0585

J. MORITA USA, INC.

9 Mason, Irvine CA 92618, USA
T +1. 949. 581 9600, F +1. 949. 581 8811

J. MORITA EUROPE GMBH

Justus-von-Liebig-Strasse 27b, 63128 Dietzenbach, Germany
T +49. (0)6074. 836 0, F +49. (0)6074. 836 299

MORITA DENTAL ASIA PTE. LTD.

150 Kampong Ampat #06-01A KA Centre, Singapore 368324
T +65. 6779. 4795, F +65. 6777. 2279

J. MORITA CORP. AUSTRALIA & NEW ZEALAND

Suite 2.05, 247 Coward Street, Mascot NSW 2020, Australia
T +61. (0)2. 9667 3555, F +61. (0)2. 9667 3577

J. MORITA CORP. MIDDLE EAST

4 Tag Al Roasaa, Apartment 902, Saba Pacha 21311 Alexandria, Egypt
T +20. (0)3. 58 222 94, F +20. (0)3. 58 222 96

J. MORITA CORP. INDIA

Felix Office No.908, L.B.S. Marg, Opp. Asian Paints, Bhandup (West), Mumbai 400078, India
T +91-82-8666-7482

J. MORITA MFG. CORP. INDONESIA

28F, DBS Bank Tower, Jl. Prof. Dr. Satrio Kav. 3-5, Jakarta 12940, Indonesia
T +62-21-2988-8332, F + 62-21-2988-8201

SIAMDENT CO., LTD.

71/10 Mu 5, Thakham, Bangpakong, Chachuengsao 24130, Thailand
T +66. 38. 573042, F +66. 38. 573043
www.siamdent.com

EU Authorized Representative under the European Directive 93/42/EEC



MEDICAL TECHNOLOGY PROMEDT CONSULTING GmbH

Altenhofstraße 80, 66386 St. Ingbert, Germany T +49. 6894 581020, F +49. 6894 581021

The authority granted to the authorized representative, MEDICAL TECHNOLOGY PROMEDT Consulting GmbH, by J. MORITA MFG. CORP. is solely limited to the work of the authorized representative with the requirements of the European Directive 93/42/EEC for product registration and incident report.

Diagnostic and Imaging Equipment

Treatment Units

Handpieces and Instruments

Endodontic Systems

Laser Equipment

Laboratory Devices

Educational and Training Systems

Auxiliaries